



EPSON Stylus COLOR 740i
Manual

Copyright Notice

All rights reserved. No part of this publication may be reproduced, stored in a retrieval system, or transmitted in any form or by any means, electronic, mechanical, photocopying, recording, or otherwise, without the prior written permission of SEIKO EPSON CORPORATION. The information contained herein is designed only for use with this EPSON printer. EPSON is not responsible for any use of this information as applied to other printers.

Neither SEIKO EPSON CORPORATION nor its affiliates shall be liable to the purchaser of this product or third parties for damages, losses, costs, or expenses incurred by purchaser or third parties as a result of: accident, misuse, or abuse of this product or unauthorized modifications, repairs, or alterations to this product, or (excluding the U.S.) failure to strictly comply with SEIKO EPSON CORPORATION's operating and maintenance instructions.

SEIKO EPSON CORPORATION shall not be liable for any damages or problems arising from the use of any options or any consumable products other than those designated as Original EPSON Products or EPSON Approved Products by SEIKO EPSON CORPORATION.

EPSON, EPSON Stylus, and ESC/P are registered trademarks and ESC/P 2 is a trademark of SEIKO EPSON CORPORATION. SoundAdvice is a service mark and PhotoEnhance and EPSON FaxAdvice are trademarks of Epson America, Inc.

General Notice: Other product names used herein are for identification purposes only and may be trademarks of their respective owners. EPSON disclaims any and all rights in those marks.

The ENERGY STAR emblem does not represent EPA endorsement of any product or service.

Copyright © 1999 by Epson America, Inc.

ESC740i0399

3/99

Contents

<i>Introduction</i>	9
Macintosh System Requirements	10
Windows System Requirements	11
Printer Parts	13
How To Use Your Manuals	14
Warnings, Cautions, Notes, and Tips	15
ENERGY STAR Compliance	15
Year 2000 Ready	16
Important Safety Instructions	16
<i>Basic Printing</i>	19
Printing from Windows	19
Setting Printer Options from Windows Applications	20
Setting Default Printer Options	23
Checking Printer Status	24
Printing from a Macintosh	27
Setting Up Background Printing Options	30

<i>Advanced Printing</i>	32
Using Custom Project Types	33
Customizing Print Quality and Special Effects	36
Customizing Color Settings	40
Using PhotoEnhance3 or Digital Camera Correction Mode	41
Using Custom Color Management Modes	42
Using a Color Correction System	45
Using ColorSync on the Macintosh	46
Selecting Paper Size and Orientation Options	48
Selecting Paper Options in Windows	49
Selecting Paper Options on a Macintosh	54
Selecting Print Layout Options	59
Choosing Print Layout Options in Windows	59
Choosing Print Layout Options on a Macintosh	69
Using Print Preview on the Macintosh	76
Saving Custom Settings	78
Redefining Custom Settings	79
Deleting Custom Settings	80

<i>Printing on Special Media</i>	81
Selecting Special Media	82
Media Loading and Handling Guidelines	84
Letterhead, Preprinted Forms, and Legal-size Paper	85
EPSON Photo Quality Glossy Paper, Film, and Transparencies	85
Envelopes	87
EPSON Photo Paper	88
EPSON Photo Quality Ink Jet Cards	91
EPSON Photo Stickers	92
EPSON Photo Quality Self Adhesive Sheets	92
EPSON Iron-On Cool Peel Transfer Paper	93
<i>Managing Print Jobs</i>	94
Managing Print Jobs in Windows 95, Windows 98, and Windows NT 4.0	95
Selecting the Speed & Progress Options	96
Using the Spool Manager	99
Using Status Monitor 2	100
Managing Print Jobs in Windows 3.1	110
Using the Spool Manager	110

Managing Print Jobs on a Macintosh	113
Using Monitor3	114
Using the Macintosh Status Monitor	117
Selecting Configuration Options	119
<i>Maintenance and Transportation</i>	121
Replacing an Ink Cartridge	122
Removing and Installing Ink Cartridges	123
Replacing an Outdated Ink Cartridge	126
Cleaning the Print Head	127
Using the Head Cleaning Utility	127
Using the Control Panel	128
Examining the Nozzle Check Pattern	130
Aligning the Print Head	131
Cleaning the Printer	132
Transporting the Printer	133
<i>Troubleshooting</i>	134
Diagnosing Problems	135
Checking the Control Panel Lights	136
Running a Printer Operation Check	137
Confirming the Printer ID Number	138

Improving Print Quality	139
Solving Printing Problems	145
Solving Printer Software Problems	149
Fixing Paper Problems	154
Solving Miscellaneous Printout Problems	157
Uninstalling Printer Software	161
Windows 95, Windows 98, and Windows NT 4.0	
Instructions	161
Windows 3.1 Instructions	162
Macintosh Instructions	162
Where To Get Help	164
<i>Specifications</i>	166
Printing	166
Paper	167
Ink Cartridges	171
Mechanical	172
Electrical	173
Environmental	173
Safety Approvals	174

DOS Support	174
Control Panel Settings	175
Character Tables	176
Interfaces	177
<i>Index</i>	179

Introduction

Your EPSON Stylus® COLOR 740i printer is the ideal output device for business graphics, layout proofs, digital photography, or any project you create on your computer. With resolutions up to 1440 by 720 dpi and EPSON's unique variable micro droplet technology, you get amazingly realistic photographic images, vivid color graphics, and razor-sharp black text.

The printer software for Macintosh® and Microsoft® Windows® and provides advanced color management with adjustable levels of brightness, contrast, sharpness, and other settings. Support for ColorSync™ 2.01 and two Windows color matching methods gives you even more precise color control.

EPSON's specially formulated ink cartridges and wide variety of ink jet papers offer the most flexibility for getting the results you want. With high-speed USB (Universal Serial Bus) and standard parallel and serial ports, setting up your printer is fast and easy.

This chapter gives you general information about your printer in these sections:

- ▶ [Macintosh System Requirements](#)
- ▶ [Windows System Requirements](#)
- ▶ [Printer Parts](#)



Caution:

If your iMac is running OS 8.1, you must download and install the iMac Update 1.0 from Apple at <http://swupdates.info.apple.com> before you install the EPSON USB printer software. Contact Apple Computer if you have problems installing this update.

If your iMac is running OS 8.5, you don't need to download and install the iMac Update 1.0; your system includes full support for the EPSON USB printer software.

- ▶ [How To Use Your Manuals](#)
- ▶ [ENERGY STAR Compliance](#)
- ▶ [Year 2000 Ready](#)
- ▶ [Important Safety Instructions](#)

Macintosh System Requirements

To use your printer and its software with a Macintosh, your system should have:

- ▶ One of the following Macintosh models:
 - LC475, LC575, LC630
 - Quadra series
 - Centris series
 - PowerBook® series (190, 520, 540, 550 or later)
 - PowerBook Duo 280, 2300c/100
 - Performa® 475, 575, 588, 630, 5210 or later
 - Power Macintosh® series
 - iMac™ Series (USB connection only)
 - Power Macintosh G3 (USB connection only)
 - ▶ For serial connection: System 7.1 or later (7.6 or later recommended); some application software on the EPSON CD-ROM may require System 7.52 or later
- For USB connection: iMac or Power Macintosh G3 with System 8.1 or later



Caution:
Using an improperly shielded USB cable—especially a cable more than 6.5 ft. (2 meters) long—may cause the printer to malfunction.

- ▶ At least 16MB of RAM (20MB or more recommended)
- ▶ At least 50MB of free hard disk space for storing images (100MB recommended)
- ▶ 13-inch RGB display or better
- ▶ Double-speed CD-ROM drive (quad-speed or faster recommended) for installing the printer software
- ▶ For serial connection, an ImageWriter® II serial cable or equivalent (8-pin mini DIN male/male, Belkin F2V024 recommended)

For USB connection to an iMac or Power Macintosh G3, a shielded USB “AB” interface cable, from Series A (computer) to Series B (printer) up to 6.5 ft. (2 meters) long

Windows System Requirements

To use your printer and its software with a PC, your system should have:

- ▶ An IBM® compatible PC with at least a 386/25 MHz (for Windows 3.1x), 486/25 MHz (for Windows 95 or Windows NT® 4.0), or 486/66 MHz (for Windows 98) processor (Pentium® processor recommended)
- ▶ DOS, Microsoft Windows 3.1x, Windows 95, Windows 98, or Windows NT 4.0



Caution:

Using an improperly shielded USB cable—especially a cable more than 6.5 ft. (2 meters) long—may cause the printer to malfunction.

- ▶ At least 16MB of RAM (32MB for Windows 3.1, 95, or 98 or 64MB for Windows NT 4.0 recommended)
 - ▶ At least 50MB of free hard disk space for storing images (100MB recommended)
 - ▶ VGA, Super VGA, or better display adapter and monitor
 - ▶ Double-speed CD-ROM drive (quad-speed or faster recommended) for installing the printer software
 - ▶ For parallel connection, a high-speed, bidirectional, IEEE-1284 compliant parallel cable (6 to 10 feet long). The cable must have a D-SUB, 25-pin, male connector for your computer and a 36-pin, Centronics® compatible connector for the printer.
- For USB connection to a computer with Windows 98 and a Windows 98 compliant USB port, a shielded USB “AB” interface cable, from Series A (computer) to Series B (printer) up to 6.5 ft. (2 meters) long

Printer Parts

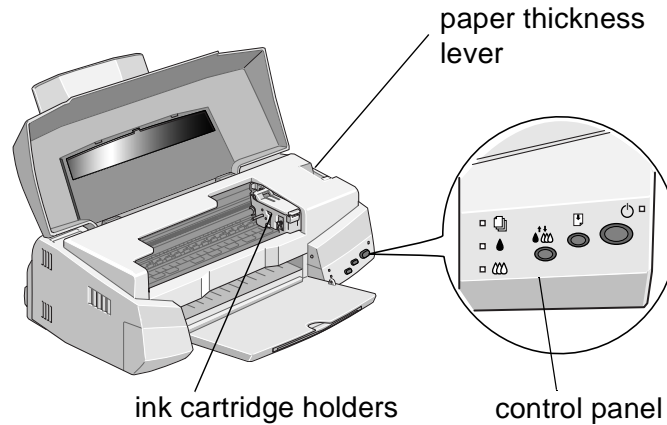
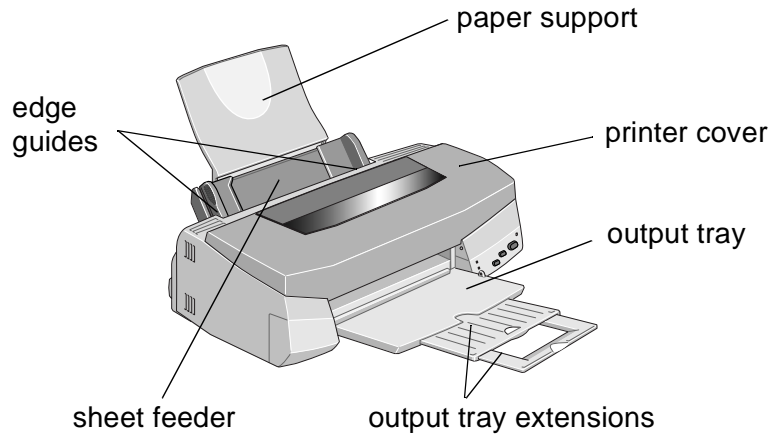

How To Use Your Manuals

To set up your printer and install the printer software, see the *Start Here* card for Macintosh instructions or the *Printer Basics* book for Windows instructions. This manual contains the following information:

[Basic Printing](#) covers the basics of printing with Windows or Macintosh.

[Advanced Printing](#) tells you how to print using custom settings for print quality, color management, and distinctive layouts.

[Printing on Special Media](#) gives guidelines for selecting the right paper or other media for your print job and instructions for loading it in your printer.

[Managing Print Jobs](#) explains how to control print jobs and check printer status while you're printing.

[Maintenance and Transportation](#) gives instructions for replacing ink cartridges, cleaning and aligning the print head, and cleaning and transporting the printer.

[Troubleshooting](#) provides solutions for any problems you may have with your printer or software.

[Specifications](#) provides the technical details on your printer, ink cartridges, and EPSON papers.

To go right to the section you need, see the [Index](#).

Warnings, Cautions, Notes, and Tips

You'll find this information throughout your manual:



Warnings must be followed carefully to avoid bodily injury.



Cautions must be observed to avoid damage to your equipment.



Notes contain important information about your printer.



Tips contain additional hints for great printing.



ENERGY STAR Compliance

As an ENERGY STAR Partner, EPSON has determined that this product meets the ENERGY STAR guidelines for energy efficiency.

The EPA ENERGY STAR Office Equipment program is a voluntary partnership with the computer and office equipment industry to promote the introduction of energy-efficient personal computers, monitors, printers, fax machines, and copiers in an effort to reduce air pollution caused by power generation.

Year 2000 Ready

Your EPSON printer is *Year 2000 Ready*. However, be sure the other parts of your computer system are also ready for the year 2000.



Caution:
Always turn the printer off using the power button. Don't switch off the electrical outlet or unplug the printer until the power light is off.

Important Safety Instructions

Before using your printer, read the following safety instructions to make sure you use the printer safely and effectively:

- ▶ Turn off and unplug the printer before cleaning. Clean with a damp cloth only. Do not spill liquid on the printer.
- ▶ Do not place the printer on an unstable surface or near a radiator or heating vent.
- ▶ Do not block or cover the openings in the printer's cabinet or insert objects through the slots.
- ▶ Use only the type of power source indicated on the printer's label.
- ▶ Connect all equipment to properly grounded power outlets. Avoid using outlets on the same circuit as photocopiers or air control systems that regularly switch on and off.

- ▶ Place the printer near a wall outlet where the plug can be easily unplugged.

Placez l'imprimante près d'une prise de contact où la fiche peut être débranchée facilement.

- ▶ Do not let the power cord become damaged or frayed.
- ▶ If you use an extension cord with the printer, make sure the total ampere rating of the devices plugged into the extension cord does not exceed the cord's ampere rating. Also, make sure the total ampere rating of all devices plugged into the wall outlet does not exceed the wall outlet's ampere rating.
- ▶ Except as specifically explained in this manual, do not attempt to service the printer yourself.
- ▶ Unplug the printer and refer servicing to qualified service personnel under the following conditions:

If the power cord or plug is damaged; if liquid has entered the printer; if the printer has been dropped or the cabinet damaged; if the printer does not operate normally or exhibits a distinct change in performance. Adjust only those controls that are covered by the operating instructions.
- ▶ Do not put your hand inside the printer or touch the cartridge during printing.
- ▶ Under normal circumstances, ink will not come out of the cartridge. If it does get on your skin, wash it off with soap and water. If it gets in your eyes, flush them immediately with water.

- ▶ Keep ink cartridges out of the reach of children.
- ▶ Do not dismantle the ink cartridges or try to refill them. This could result in damage to the print head.
- ▶ Once you install an ink cartridge, do not open the clamp or remove the cartridge except to replace it with a new one. The cartridge may become unusable otherwise.
- ▶ Install the ink cartridge immediately after you remove it from its foil package. Leaving the cartridge unpacked for a long time before use may result in reduced print quality.
- ▶ Do not use an ink cartridge beyond the date printed on the cartridge package. For best results, use up the ink cartridges within six months of installing them.
- ▶ Do not shake an ink cartridge; this can cause leakage.
- ▶ Always turn the printer off using the ⏻ power button. When you press this button, the ⏻ power light flashes briefly then goes out. Do not unplug the printer or turn off the power to the outlet until the ⏻ power light is off.
- ▶ Before transporting the printer, make sure the print head is capped in the far right position and the ink cartridges are in place.

Basic Printing



Note:
For instructions on
printing with DOS,
see [DOS Support](#).

It's easy to print all your color and monochrome documents with your EPSON Stylus COLOR 740i. First set up your printer and install the software, following the instructions in the *Start Here* card or *Printer Basics* book. Read this chapter to find out about:

- ▶ [Printing from Windows](#)
- ▶ [Printing from a Macintosh](#)

Although your printer is named the EPSON Stylus COLOR 740i, be sure to select EPSON Stylus COLOR 740 in your application (Windows) or SC 740 in the Chooser (Macintosh).

Printing from Windows

This section tells you about:

- ▶ [Setting Printer Options from Windows Applications](#)
- ▶ [Setting Default Printer Options](#)
- ▶ [Checking Printer Status](#)

Setting Printer Options from Windows Applications



Note:

You can also set printer options by clicking Print Setup in the File menu, then clicking the Printer, Setup, Properties, or Options button. However, in most applications you'll then have to select the Print option from the File menu to print using your changes.

This section describes the settings you'll need to check for all your everyday printouts. See [Advanced Printing](#) for information about advanced settings for special print jobs.

- 1 Open a Windows application and select a file you want to print.
- 2 Open the File menu and click **Print**. You see the Print dialog box for your application.

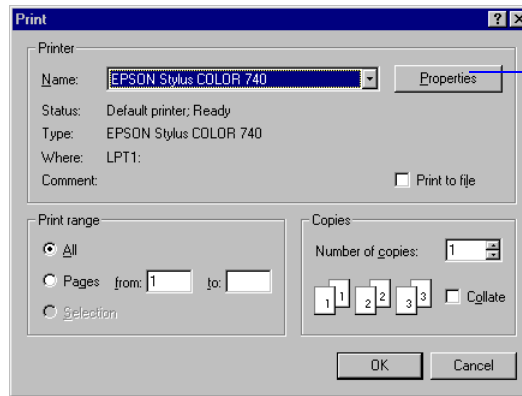

- 3 Make sure your EPSON Stylus COLOR 740 printer is selected, and then click the **Properties**, **Printer**, **Setup**, or **Options** button. (You may have to click a sequence of buttons in different dialog boxes.)

You then see the printer settings dialog box:

Click to select your media type

Click to select Automatic mode

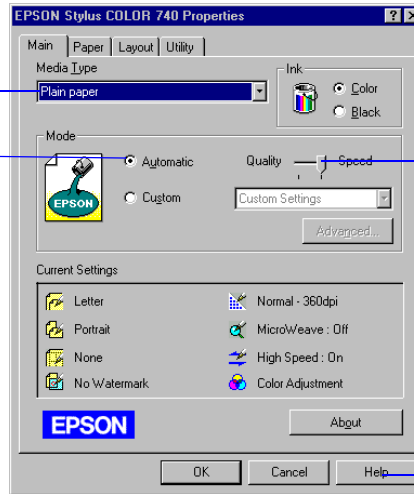

Use the Quality/Speed slider to select your print resolution

Click for more information



To print at the highest resolution (1440 dpi), you need to use plain paper, Photo Paper, or one of the Photo Quality media. For the best printing at any resolution, always use EPSON media.

- 4 Click the **Main** tab if necessary. Then choose the **Media Type** you want to print on from the following list:
 - ▶ **Plain paper**
 - ▶ **360 dpi Ink Jet Paper**
 - ▶ **Photo Quality Ink Jet Paper**
 - ▶ **Photo Paper**
 - ▶ **Photo Quality Glossy Film**
 - ▶ **Ink Jet Transparencies**

The type of paper you choose determines the print quality (resolution) you can use. It's very important to select the correct setting for your paper. If you're not sure which to choose, see [Selecting Special Media](#).

- 5 Choose **Color** or **Black** ink.
- 6 Now make sure the Mode option is set to **Automatic**. This is the easiest way to get good printing results for all kinds of documents, on all types of paper.
- 7 Set the slider to **Quality** or **Speed**. This lets you choose between the fastest printing or a high resolution for the media you're using.

To select 1440 dpi on plain paper or any other available resolution for your media, you need to access the Advanced dialog box; see [Customizing Print Quality and Special Effects](#) for instructions.

- 8 Click the **Paper** tab and choose your paper size, number of copies, orientation, and printable area settings. See [Selecting Paper Options in Windows](#) for instructions.
- 9 Click the **Layout** tab (not available with Windows 3.1) and check the reduce/enlarge, page layout, and watermark settings. See [Choosing Print Layout Options in Windows](#) for details.
- 10 Click **OK** when you're finished checking your settings. The dialog box closes. Click **OK** until you see the Print dialog box.
- 11 In the Print dialog box, click **OK** or **Print**.



Note:
The Quality/Speed slider is not available for certain media types.

While your document is printing, a window appears showing the printer status and the progress of your print job. See [Checking Printer Status](#) for more information.

Setting Default Printer Options

When you change printer settings through your software application, the settings apply only to the application you're using. To adjust the default settings for **all** your Windows applications, access the printer settings through the Printers utility or Control Panel (Windows 3.1). Close all your applications before you start. If you don't, you may have to close and reopen them to use the new default settings.



Note:

You can access the default Windows NT printer software settings only if you have the appropriate network access privileges, such as Administrator.

Setting Default Options in Windows 95, Windows 98, or Windows NT

- 1 Click **Start**, point to **Settings**, and select **Printers**.
- 2 Right-click the **EPSON Stylus COLOR 740** icon.
- 3 Select **Properties** or **Document Defaults** (Windows NT), then click the **Main** tab. You see the printer settings dialog box shown under [Setting Printer Options from Windows Applications](#) with some additional tabs at the top.

Setting Default Options in Windows 3.1

- 1 Double-click the **Control Panel** icon in the Main group.
- 2 Double-click the **Printers** icon.
- 3 Select **EPSON Stylus COLOR 740** from the list of printers and click **Setup**. You see the printer settings dialog box shown under [Setting Printer Options from Windows Applications](#).

Checking Printer Status

While your document is printing, your printer software reports how the job is doing. See the following for your operating system:

- ▶ [Windows 95, Windows 98, or Windows NT 4.0](#)
- ▶ [Windows 3.1](#)

Windows 95, Windows 98, or Windows NT 4.0

After you send a print job in Windows 95, 98, or NT, the Progress Meter window appears on your screen:

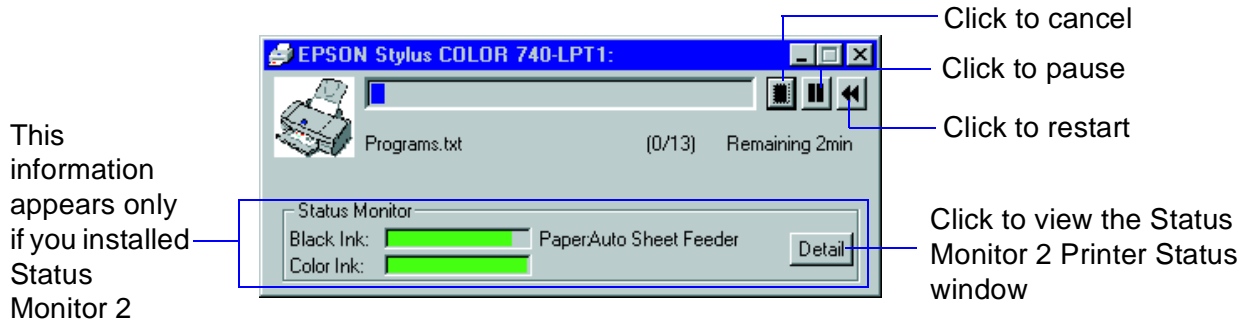

The Progress Meter shows the progress of your print job and the status of your printer. You can use the buttons to cancel, pause, or restart your print job.

If you installed Status Monitor 2, you also see information about how much ink you have left and can view the Status Monitor 2 Printer Status window. See [Using Status Monitor 2](#) for more information.

You can also set up the way your printer software sends print jobs and select whether to display the Progress Meter dialog box or not; see [Selecting the Speed & Progress Options](#) for instructions.

Windows 3.1

After you send your print job, the EPSON Despooler dialog box appears on your screen:

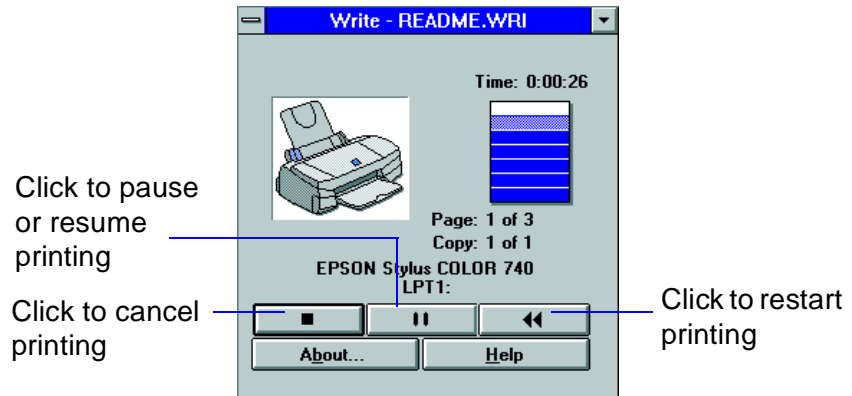

This dialog box shows the progress of your print job and the status of your printer. If you run out of paper while printing, for example, the Despooler warns you. You can use the buttons to cancel, pause, or restart your print job.

You can also control print jobs using the Spool Manager; see [Using the Spool Manager](#) for more information.



Note:

On the Macintosh, printer settings are saved with your document, but not from one application to another. If you want to reuse settings, you can create document templates for your favorite applications.

You can also create custom setting groups in your printer software that you can select each time you open an application. See [Saving Custom Settings](#) for details.

Printing from a Macintosh

When you print with a Macintosh, you need to check the printer software settings in each application you use. This section describes the settings you'll need to check for all your everyday printouts. See [Advanced Printing](#) for information about advanced settings for special print jobs.

Follow these steps to print from a Macintosh:

- 1 Open a Macintosh application and select a file you want to print.
- 2 Open the File menu and click **Page Setup (Document Setup** in some applications). You see the Page Setup dialog box:

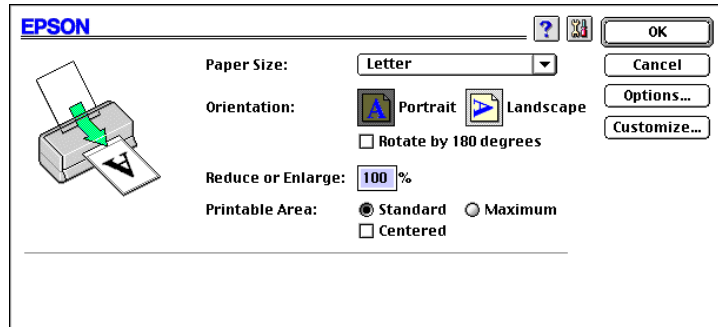

- 3 Choose your paper size, orientation, and other options as described in [Selecting Paper Options on a Macintosh](#) and click **OK**.

- Now open the File menu and click **Print**. You see the main printer settings dialog box:

Click to select your media type

Click to select Automatic mode

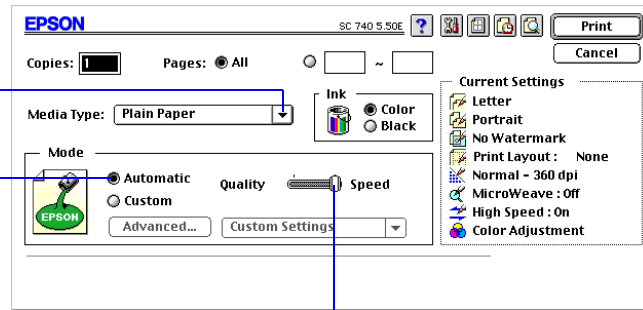

Use the Quality/Speed slider to select your print resolution





For printing at the highest resolution (1440 dpi), you need to use plain paper, Photo Paper or one of the Photo Quality media. For the best printing at any resolution, always use EPSON media.

- Choose the number of copies and indicate which pages you want to print.
- Choose the **Media Type** you want to print on from the following list:
 - ▶ **Plain Paper**
 - ▶ **360 dpi Ink Jet Paper**
 - ▶ **Photo Quality Ink Jet Paper**
 - ▶ **Photo Paper**
 - ▶ **Photo Quality Glossy Film**
 - ▶ **Ink Jet Transparencies**



Note:
The Quality/Speed
slider is not available
for certain media
types.

The type of paper you choose determines the print quality (resolution) you can use. It's very important to select the correct setting for your paper. If you're not sure which to choose, see [Selecting Special Media](#).

- 7 Choose **Color** or **Black** ink.
- 8 Make sure the Mode option is set to **Automatic**. This is the easiest way to get good printing results for all kinds of documents, on all types of paper.
- 9 Set the slider to **Quality** or **Speed**. This lets you choose between the fastest printing or a high resolution for the media you're using. To select 1440 dpi on plain paper or any other available resolution for your media, you need to access the Advanced dialog box; see [Customizing Print Quality and Special Effects](#) for instructions.
- 10 Click the  Layout icon and check the fit to page, watermark, page layout, and print order settings. See [Choosing Print Layout Options on a Macintosh](#) and [Selecting Print Order Options](#) for details. Then click **OK** to return to the printer settings dialog box.
- 11 To select background printing options for your print job before you print, click the  Background Printing icon. See [Setting Up Background Printing Options](#) for details.

- 12 If you want to preview your printout to view how the current layout, watermark, print order, and orientation settings look, click the  Preview icon, then click the **Preview** button. See [Using Print Preview on the Macintosh](#) for details.
- 13 Click **Print** when you're finished checking your settings.
If you chose background printing when you set up your printer, you can continue working while your document is printing. See [Using Monitor3](#) for details.



Note:
You can also turn background printing on or off in the Macintosh Chooser.

Setting Up Background Printing Options

Before you print your document, you can set up the following background printing options:

- ▶ Turn background printing on or off
- ▶ Set a priority for the print job in the print queue
- ▶ Set a specific time for printing the print job
- ▶ Hold the print job for later printing

Follow these steps:

- 1 Open an application and select a document you want to print.
- 2 Open the File menu and click **Print**. You see the printer settings dialog box.
- 3 Click the  Background Printing icon.

You see the following dialog box:

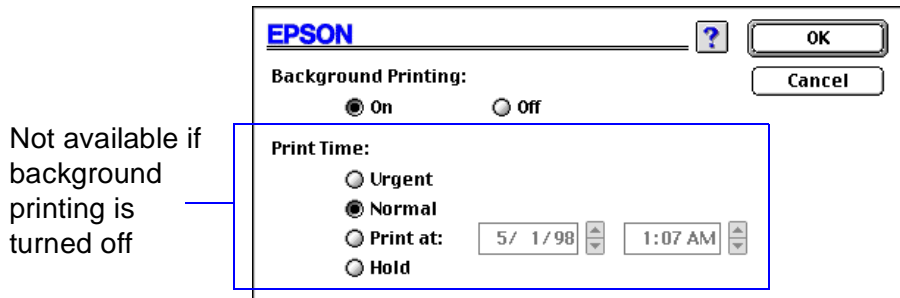

- 4 To turn background printing on or off, click the **On** or **Off** radio button.
- 5 To select a priority for your print job in the queue of jobs waiting to print, click one of the following:
 - ▶ **Normal** to print in the order the job is received
 - ▶ **Urgent** to print before any Normal priority job
 - ▶ **Print at:** to print at the specific time you enter in the day and time in the fields to the right
 - ▶ **Hold** to hold the print job in the print queue until you're ready to release it using EPSON Monitor 3; see [Using Monitor3](#) for details.
- 6 Click **OK** to save your settings and return to the printer settings dialog box. (Click **Cancel** if you want to cancel your settings and return.)

Advanced Printing



Note:

Although your printer is named EPSON Stylus COLOR 740i, be sure to select EPSON Stylus COLOR 740 in your application (Windows) or SC 740 in the Chooser (Macintosh).

When your presentation graphics, photographs, or other projects have special printing requirements, you can use the advanced settings in your EPSON Stylus COLOR 740 software. You can choose custom project types or adjust individual settings like brightness, contrast, sharpness, and halftoning. For professional-quality color accuracy, you can use a color matching mode.

Your printer software's print layout options let you print almost any size image on your printer, proof multiple pages on one sheet of paper, and add watermarks (not available with Windows 3.1).

This chapter includes the following information:

- ▶ [Using Custom Project Types](#)
- ▶ [Customizing Print Quality and Special Effects](#)
- ▶ [Customizing Color Settings](#)
- ▶ [Using ColorSync on the Macintosh](#)
- ▶ [Selecting Paper Size and Orientation Options](#)
- ▶ [Selecting Print Layout Options](#)
- ▶ [Using Print Preview on the Macintosh](#)
- ▶ [Saving Custom Settings](#)

Using Custom Project Types

Custom project types provide an easy way to fine-tune your printer settings for a specific type of project. Follow these steps to print with custom project types:

- 1 Create your image or document in your application software.
- 2 Access the printer settings dialog box as described in [Printing from Windows](#) or [Printing from a Macintosh](#). You see one of the following dialog boxes:

Click **Custom**, then click here to see a list of project types

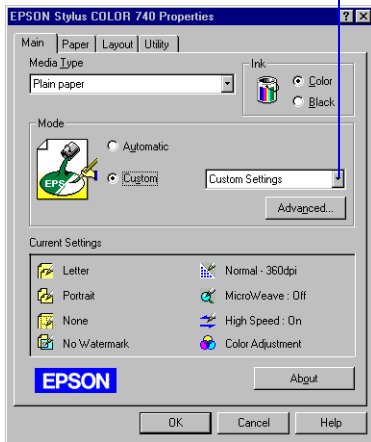

Windows 95, 98, NT

Click **Advanced**, then click here to see a list of project types

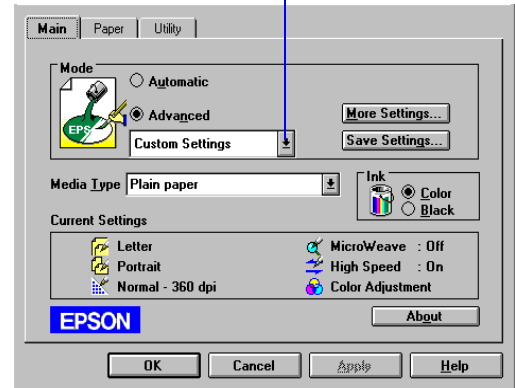

Windows 3.1

Click **Custom**, then click here to see a list of project types

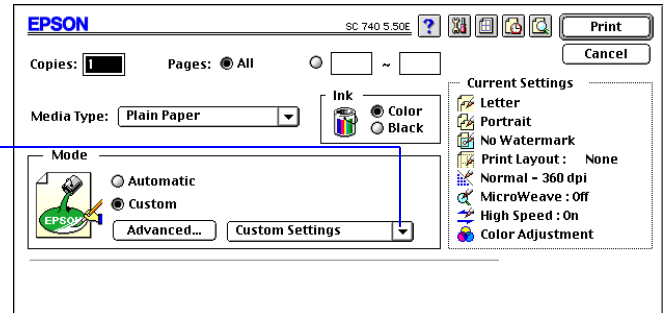

Macintosh

- 3 Choose the **Media Type** you want to print on. (If you're not sure which setting to choose, see [Selecting Special Media.](#))
- 4 Choose **Color** or **Black** ink.
- 5 Click **Custom** (in Windows 3.1, click **Advanced**), and then click **Custom Settings**. You see the list of project types.
- 6 Choose the right setting for your project and **Media Type** following these guidelines:
 - ▶ **PhotoEnhance3** (Windows 95, 98, NT, or Macintosh) or **PhotoEnhance™** (Windows 3.1)
For printing images captured using a video camera, digital camera, or scanner. Produces sharper images and more vivid colors by automatically adjusting the contrast, saturation, and brightness. Corrects for overall under- and over-exposure of the original image.



Note:
Always choose your Media Type and Ink setting before you select a custom project type. Some project types may not be available with the Media Type or Ink settings you choose.

Printing with PhotoEnhance3 or PhotoEnhance may take longer on some systems and images.

- ▶ **Digital Camera** (not available with Windows 3.1)
For printing images captured using a scanner or digital camera. Corrects noise and other common flaws.
- ▶ **Text/Graph**
For printing graphics-intensive documents like presentation pages with charts and graphs. Intensifies colors and lightens the midtones and highlights.
- ▶ **Economy**
For rough drafts of text only. Saves ink.
- ▶ **ICM** (Windows 95 and Windows 98 only)
For printing documents created in an ICM compatible application. If you're using an ICM compatible monitor, adjusts printed colors to closely match the screen colors.
- ▶ **sRGB** (Standard Red Green Blue; not available with Windows 3.1; recommended only with Windows 98)
For printing documents created in an sRGB compatible application using sRGB colors, such as those designed for the World Wide Web. First set up your sRGB compatible devices (such as your monitor and printer) to use an sRGB color profile; see your Windows 98 online help for details.
- ▶ **ColorSync** (Macintosh only)
Automatically adjusts printout colors to closely match the colors on your screen. For more information, see [Using ColorSync on the Macintosh](#).

- 7 In Windows, click the **Paper** and **Layout** tabs (not available on Windows 3.1) to check or change any necessary settings, as described in [Selecting Paper Options in Windows](#) and [Choosing Print Layout Options in Windows](#).

On a Macintosh, check or change any necessary settings on the Page Setup and the Layout dialog boxes as described in [Selecting Paper Options on a Macintosh](#) and [Choosing Print Layout Options on a Macintosh](#).

- 8 When you're finished, click **OK** (Windows) or **Print** (Macintosh). If you're using Windows, click any other buttons that your application uses for printing.



After you customize your print settings for a special project, you can save them as a group. Then you can reuse them whenever you print a similar project. See [Saving Custom Settings](#) for instructions.

Customizing Print Quality and Special Effects

If you need the maximum control over your project, or you want to experiment with special effects, you can adjust the custom settings in your printer software. Follow these steps:

- 1 Create your image or document in your application software.
- 2 Access the printer settings dialog box as described in [Printing from Windows](#) or [Printing from a Macintosh](#).
- 3 Click **Custom**, and then click the **Advanced** button. (In Windows 3.1, click **Advanced**, then click the **More Settings** button.)

You see the Advanced dialog box (called More Settings in Windows 3.1):

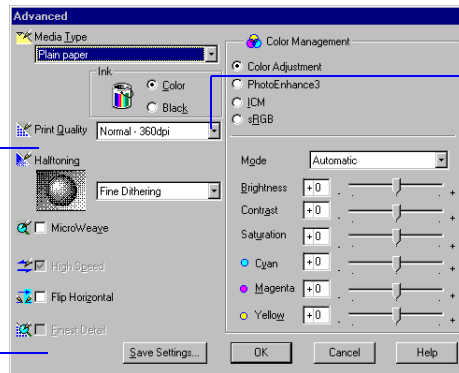

Click here to change your Print Quality (resolution)

Some of these options are automatically set or disabled by other settings you choose

Windows 95, 98, NT

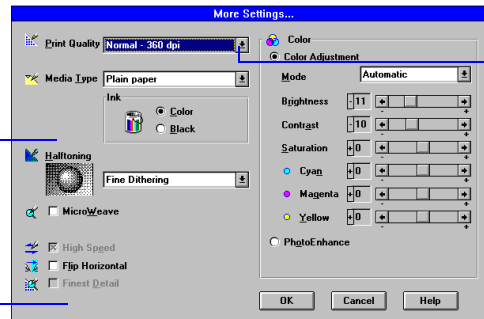

Click here to change your Print Quality (resolution)

Some of these options are automatically set or disabled by other settings you choose

Windows 3.1

Click here to change your Print Quality (resolution)

Some of these options are automatically set or disabled by other settings you choose

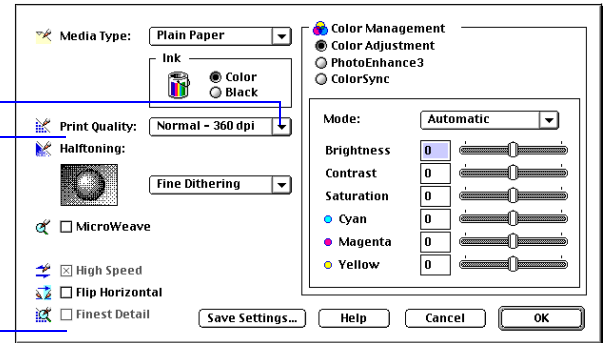

Macintosh



Note:

The available Print Quality settings may be limited by the Media Type you choose.

- 4 Choose the **Media Type** and **Ink** settings you want to use, following the guidelines in [Printing from Windows](#) and [Printing from a Macintosh](#).
- 5 Choose one of the following **Print Quality** options:
 - ▶ **Economy**
For low-resolution rough drafts on plain paper. Saves ink.
 - ▶ **Normal - 360 dpi**
For most documents on plain paper, transparencies, or 360 dpi Ink Jet Paper.
 - ▶ **Fine - 720 dpi**
For high-resolution output on plain paper, Photo Paper, or Photo Quality Ink Jet Paper.



Note:

In Automatic mode, the Halftoning setting is selected based on the data in your print job. In Custom mode, Halftoning is preselected for each project type setting.

Some of the print options at the bottom left of the Advanced dialog box are automatically selected or disabled by the Print Quality (resolution) you choose.

- ▶ **Photo - 720 dpi**
Excellent high-resolution output on plain paper, Photo Paper, or Photo Quality Ink Jet Paper.
- ▶ **Photo - 1440 dpi**
For the highest-resolution output on plain paper, Photo Paper, or Photo Quality media.

6 Choose one of the following **Halftoning** options:

- ▶ **No Halftoning**
For printing black text only.
- ▶ **Error Diffusion**
For printing photographic images. Blends each color dot with the dots around it.
- ▶ **Fine Dithering**
For printing graphs or other images that require precise, solid areas of bright colors.

7 Choose any of the following print options:

- ▶ **MicroWeave**
For improved print quality. Prints graphic data in finer increments to eliminate unwanted banding effects (light horizontal lines). Always use for color printing.
- ▶ **High Speed**
For fast, bidirectional printing at lower quality. If vertical lines in your printout are misaligned when you use the High Speed setting, you may need to turn it off or align the print head; see [Aligning the Print Head](#) for instructions.

- ▶ **Flip Horizontal**
Prints a mirror image of your document. Use with iron-on transfer paper so your ironed-on printout will read correctly.
 - ▶ **Finest Detail**
For printing text, graphics, and line art with very sharp edges. Slows print speed and increases your system memory requirements.
- 8 Click **OK** if you're ready to return to the printer settings dialog box, or see [Customizing Color Settings](#) if you want to adjust your document's color settings.

Customizing Color Settings



Note:

The appearance of the Color section of the More Settings dialog box always appears as shown in [Using Custom Color Management Modes on Windows 3.1](#).

There are three ways to manage the color in your documents using your printer software:

- ▶ [Using PhotoEnhance3 or Digital Camera Correction Mode](#) to automatically correct digital photographs for exposure and other common flaws, and to adjust the tone or sharpness.
- ▶ [Using Custom Color Management Modes](#) to select individual color values to fine-tune the color in text, graphics, or economy mode documents.
- ▶ [Using a Color Correction System](#) for maximum color accuracy.

The appearance of the Color Management section of the Advanced dialog box changes, depending on the settings you've selected.



Note:
The Color Management section also changes to this view if you select the PhotoEnhance3 radio button on the Advanced dialog box.

Using PhotoEnhance3 or Digital Camera Correction Mode

To correct the exposure, tone, and sharpness of digital images, you can use PhotoEnhance3 (PhotoEnhance on Windows 3.1) and/or Digital Camera Correction mode (not available with Windows 3.1).

- 1 Create your image or document in your application software.
- 2 Access the printer settings dialog box as described in [Printing from Windows](#) or [Printing from a Macintosh](#).
- 3 Click **Custom**, then select either **PhotoEnhance3** or **Digital Camera** as described in [Using Custom Project Types](#).
- 4 Click the **Advanced** button. The Color Management section of the Advanced dialog box appears as shown here:

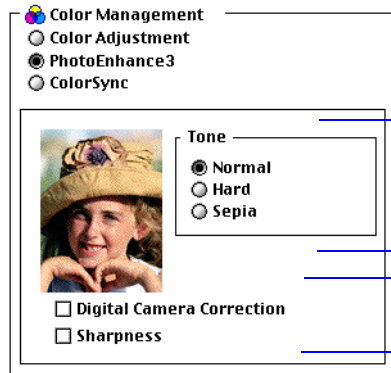

Macintosh

Click to select a Tone setting, if necessary. Changes are shown in the example photograph.

Click to turn on Digital Camera Correction mode and/or sharpen the image.

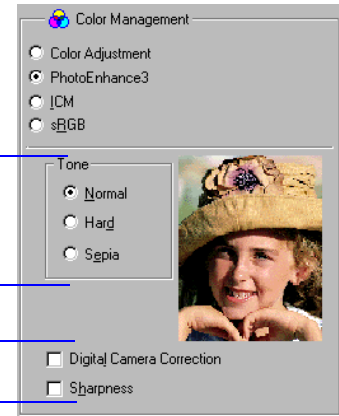

Windows 95, 98, NT

- 5 You can customize your image using these settings:
 - ▶ Select a Tone setting for your image: **Normal** for standard tones, **Hard** for high contrast, or **Sepia** for an old-fashioned photo look.
 - ▶ Turn on **Digital Camera Correction** to correct noise and other flaws common to digital camera images.
 - ▶ Select **Sharpness** to sharpen the image, especially the edges.
- 6 Click **OK** to return to the printer settings dialog box.

Using Custom Color Management Modes

You can choose from several custom Color Management modes or manually adjust brightness, contrast, saturation, and CMY (cyan, magenta, yellow) color values.

- 1 Create your image or document in your application software.
- 2 Access the printer settings dialog box as described in [Printing from Windows](#) or [Printing from a Macintosh](#).
- 3 Click **Custom** (in Windows 3.1, click **Advanced**), then select either **Text/Graph** or **Economy** as described in [Using Custom Project Types](#).



Note:
The Color Management section also changes to this view if you did not select a Custom project type or if you select the Color Adjustment radio button on the Advanced dialog box.

- Click the **Advanced** button. The Color Management section of the Advanced dialog box appears as shown here:

Not available with Windows 3.1; ICM not available with Windows NT

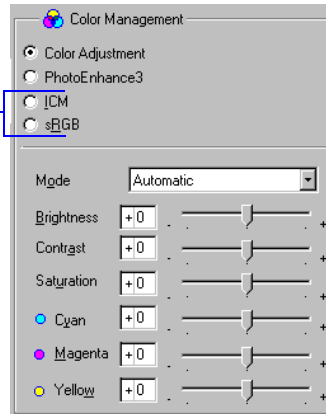

Windows

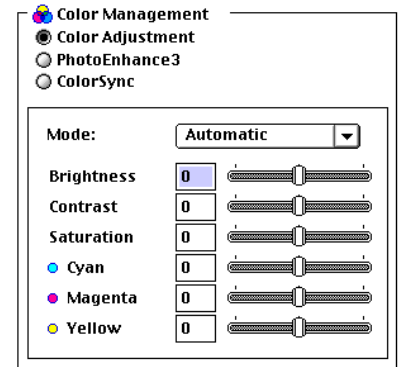

Macintosh

- Choose one of the following **Color Adjustment Modes**:
 - **Automatic**
Analyzes the color information in your project and optimizes color correction accordingly.
 - **Photo-realistic**
For printing color photographs.
 - **Vivid**
For printing graphics-intensive documents like presentation pages with charts and graphs. Intensifies colors and lightens the midtones and highlights.

- ▶ **No Color Adjustment**
Disables the color adjustment features of the printer software so you can use a stand-alone color management utility.
- 6 If you want to specify individual color correction values, use the sliders to increase (drag right) or decrease (drag left) the settings listed below.
- ▶ **Brightness**
Makes your image lighter or darker.
 - ▶ **Contrast**
Increases or decreases the difference between the bright or dark parts of an image.
 - ▶ **Saturation**
Makes colors more vivid or less vivid.
 - ▶ **Cyan, Magenta, Yellow**
Increases or decreases the amount of the three ink colors that combine to make a full-color picture. Use these sliders to fine-tune the color balance in your printout.
- 7 Click **OK** to return to the printer settings dialog box.



Note:
The Color Management section also changes to this view if you select the **ICM**, **sRGB**, or **ColorSync** radio button on the Advanced dialog box.

Using a Color Correction System

To achieve the maximum color accuracy, you can use Image Color Matching (ICM; Windows 95 and 98 only), Standard Red Green Blue (sRGB; Windows 95, 98, and NT only), or ColorSync (Macintosh only), if your system is set up to use them.

- 1 Create your image or document in your application software.
- 2 Access the printer settings dialog box as described in [Printing from Windows](#) or [Printing from a Macintosh](#).
- 3 Click **Custom**, then select either **ICM** (Windows 95 or 98 only), **sRGB** (Windows 95, 98, and NT only), or **ColorSync** (Macintosh only) as described in [Using Custom Project Types](#).
- 4 Click the **Advanced** button. The Color Management section of the Advanced dialog box appears as shown here:

Not available with Windows NT

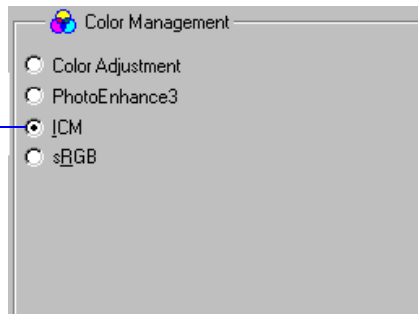

Windows 95, 98, NT

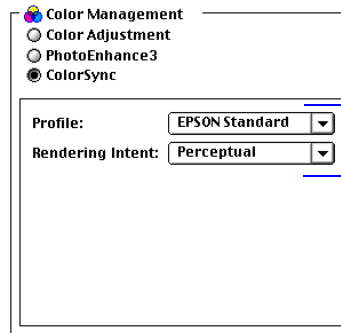

Macintosh

For details, see [Using ColorSync on the Macintosh](#)

- 5 Select one of these color correction systems:
 - ▶ **ICM** (Windows 95 and Windows 98 only)
For printing documents created in an ICM compatible application. If you're using an ICM compatible monitor, adjusts printed colors to closely match the screen colors.
 - ▶ **sRGB** (Standard Red Green Blue; not available with Windows 3.1; recommended only with Windows 98)
For printing documents created in an sRGB compatible application using sRGB colors, such as those designed for the World Wide Web. First set up your sRGB compatible devices (such as your monitor and printer) to use an sRGB color profile; see your Windows 98 online help for details.
 - ▶ **ColorSync** (Macintosh only)
Automatically adjusts printout colors to match colors on the screen. See [Using ColorSync on the Macintosh](#) for more information.
- 6 Click **OK** to return to the printer settings dialog box.

Using ColorSync on the Macintosh

Every device you use for producing or viewing colors—your monitor, scanner, and printer—employs a different color technology. The Macintosh ColorSync system helps you control all your devices so their colors match your printer's as closely as possible.



Note:

When you install your printer software, you automatically install the ColorSync profile for your printer. If your system doesn't have ColorSync, the installer also automatically installs ColorSync 2.0. If you already have ColorSync 2.0, or a later version, the installer doesn't install ColorSync.

ColorSync uses profile information from each device—including your EPSON Stylus COLOR 740i printer—to achieve accurate color matching. First you have to make sure your monitor's profile is set. Then you can use your printer software to specify the exact method of color matching you want to use.

Follow these steps to set your monitor's ColorSync profile and use your printer software's ColorSync features. The steps may be different or there may be additional steps, depending on your Macintosh OS version; see your Macintosh documentation for more information on setting up ColorSync.

- 1 Open the **ColorSync System Profile** under **Control Panels** on the Apple menu.
- 2 Click the **Set Profile** button.
- 3 Select your monitor from the list, and then click **Select**.
- 4 Close ColorSync System Profile.
- 5 Open an application and select a document to print.
- 6 Open the File menu and click **Print**.
- 7 Click **Custom**, then click **Advanced**. You see the Advanced dialog box.
- 8 Click the **ColorSync** radio button.
- 9 For **Profile**, choose **EPSON Standard**. This is the ColorSync profile created especially for your printer. **Don't choose any other printer profile you may have on your system.**



Note:
The Rendering Intent options may be limited by the Media Type you've selected.

- 10 Choose one of the following options for **Rendering Intent**:
 - ▶ **Perceptual**
For printing scanned photographs.
 - ▶ **Saturation**
For printing graphics-intensive documents like presentation pages with charts and graphs.
 - ▶ **Colorimetric**
For matching colors on your screen as exactly as possible. Reproduces colors the way your eye distinguishes them.
- 11 Click **OK** to return to the printer settings dialog box.

Selecting Paper Size and Orientation Options

Your printer can print on paper up to 9.5 inches wide and up to 44 inches long in either portrait or landscape orientation. If you print multi-page documents or multiple copies of documents, you can print the pages collated and in reverse order. You can even rotate the printed document by 180 degrees to make it closer to the bottom of the paper (not available with Windows 3.1).

Follow the steps in the section for your operating system:

- ▶ [Selecting Paper Options in Windows](#)
- ▶ [Selecting Paper Options on a Macintosh](#)

Selecting Paper Options in Windows

Follow these steps to select paper options on the Paper tab:

- 1 Create your image or document in your application software.
- 2 Access the printer settings dialog box as described in [Printing from Windows](#).
- 3 Click the **Paper** tab. You see the Paper dialog box:

Printer graphic reflects changes to Orientation and Printable Area settings

Click to select your Paper Size

Page graphics change to show Collate and Reverse Order settings

Rotate by 180° is not available with Windows 3.1



Note:

If the Reduce/Enlarge setting is set to Normal and you select one of the paper sizes to the right that is marked with an asterisk (*), you see a dialog box asking you to select a paper size that fits your printer. See [Reducing and Enlarging Your Document Size](#) for more information.

- 4 Click the **Paper Size** drop-down list to select the size of paper you loaded in the printer.

The sizes marked with an asterisk (*) are larger than you can load in the printer and can be used only with the **Reduce/Enlarge** setting on the Layout tab; see [Reducing and Enlarging Your Document Size](#) for more information.

A4 210 × 297 mm

B5 182 × 257 mm

A5 148 × 210 mm

Letter 8 1/2 × 11 in

Legal 8 1/2 × 14 in

Executive 7 1/4 × 10 1/2 in

Half Letter 5 1/2 × 8 1/2 in

A6 Index card 105 × 148 mm

Index card 5 × 8 in

Index card 8 × 10 in

Envelope #10 4 1/8 × 9 1/2 in

Envelope DL 110 × 220 mm

Envelope C6 114 × 162 mm

Envelope 132 × 220 mm

Photo Paper 4 × 6 in

Panoramic 210 × 594 mm

B4 257 × 364 mm *

US B 11 × 17 in *

A3 297 × 420 mm *

Super A3/B 329 × 483 mm *

B3 364 × 514 mm *

A2 420 × 594 mm *

US C 17 × 22 in *

User Defined (See [Creating User Defined Paper Sizes](#) for instructions.)

- 5 If you did not or cannot select the number of copies you want to print in your application program's Print dialog box, choose the number in the **Copies** box. **Don't select the number of copies here and in your application's Print dialog box; you may get twice the number of copies you want.**



Note:

The **Rotate by 180°** setting lets you print the lower portion of a document first, with a bottom margin as small as 0.12 inch (3 mm) and a top margin as small as 0.55 inch (14 mm). This option is not available with Windows 3.1.

When you select **Maximum** as the Printable Area setting, print quality may decrease in the expanded printable area in the bottom margin.

- 6 If you're printing multiple copies of a multi-page document and you want the copies printed in sets, click the **Collate** checkbox. The page graphics change to show collated documents.
- 7 If you're printing a multi-page document and want the last page printed first so the pages come out without needing to be reordered, click the **Reverse Order** checkbox. The page graphics change to show later pages printing first.
- 8 Select the direction of printing on the page with the **Orientation** options. To print your document oriented as shown in one of the following illustrations, select the options listed below it.

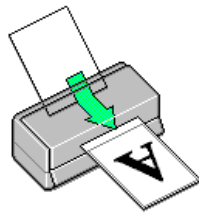

Portrait

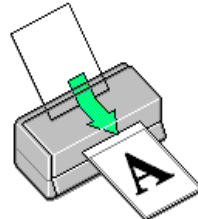

Portrait and
Rotate by 180°

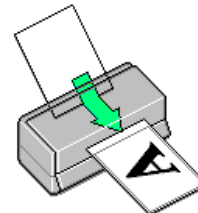

Landscape

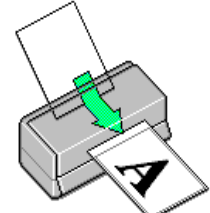

Landscape and
Rotate by 180°

- 9 The **Standard** Printable Area setting uses the maximum printable area of your paper with a minimum bottom margin of 0.55 inch (14 mm). To increase the minimum bottom margin to 0.12 inch (3 mm), set the Printable Area setting to **Maximum**. To center your document on the page using either setting, select the **Centered** checkbox.

- 10 Click a tab for the settings you want to check or change next, or click **OK** to print your document.

Creating User Defined Paper Sizes

You can create up to 10 custom paper sizes (one in Windows 3.1) and add them to the **Paper Size** list using the **User Defined** option. This is useful if you're printing a custom size document, such as a banner. You can select any width from 3.5 to 9.5 inches, and any height (length) from 3.5 to 44 inches.

Follow these steps to create a **User Defined** paper size:

- 1 Follow the steps in [Printing from Windows](#) to access the printer software, then click the **Paper** tab.
- 2 Click the **Paper Size** list and scroll to the bottom of it using the arrows or scroll bar.
- 3 Click the **User Defined** option. You see one of the following dialog boxes:

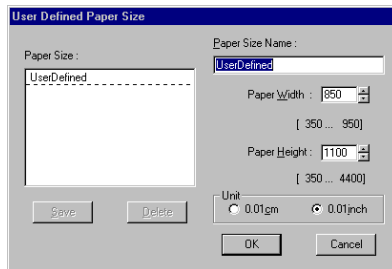

Windows 95, 98, NT

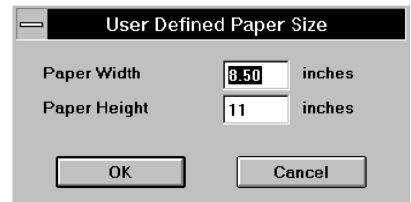

Windows 3.1



Note:

In Windows 95, 98, and NT, the Paper Width and Paper Height units are in hundredth of an inch (or centimeter) increments. For example, 850 equals 8.50 inches.

4 **Windows 95, Windows 98, or Windows NT**

Type a name (up to 24 characters) for your custom paper size in the **Paper Size Name** field. Then select a **Paper Width** and **Paper Height** for the paper. To use centimeters instead of inches, click the **0.01cm** option. When you're finished, click **Save**. The paper size name appears in the **Paper Size** list in the dialog box. Add more sizes if you want, and click **OK** when you're done.

Windows 3.1

You can create only one User Defined paper size. Type the width in the **Paper Width** field and the length in the **Paper Height** field. Then click **OK**.

- 5 You see the **Paper** tab again. The paper size name you defined is added to the **Paper Size** list and selected as the current setting. (In Windows 3.1, the setting is named **User Defined**.)
- 6 Click a tab for the settings you want to check or change next, or click **OK** to print your document

To change or delete a custom paper size:

Windows 95, Windows 98, or Windows NT

Click **User Defined** in the Paper Size list. Then, on the User Defined Paper Size dialog box, select the custom paper name in the Paper Size list and change the **Paper Width**, **Paper Height**, and/or **Unit** settings as necessary, or click **Delete**. Click **OK** when you're done.

Windows 3.1

You can change the custom paper size, but cannot delete it. Click **User Defined** in the Paper Size list. Then, on the User Defined Paper Size dialog box, change the **Paper Width** and **Paper Height** settings as necessary. Click **OK** when you're done.

Selecting Paper Options on a Macintosh

The **Paper Size** and **Orientation** options for your printer software are on the Page Setup dialog box. The options for collating and reversing the page order are on the Layout dialog box. Follow the steps in these sections for selecting the paper options:

- ▶ [Choosing Paper Size and Orientation Options](#)
- ▶ [Selecting Print Order Options](#)

Choosing Paper Size and Orientation Options

Follow these steps to select the **Paper Size** and **Orientation**:

- 1 Create your image or document in your application software.
- 2 Open the File menu and select **Page Setup**. You see the Page Setup dialog box:

Printer graphic reflects changes to Orientation and Printable Area settings

Click to select your Paper Size

Click to select your Orientation options

Click to select your Printable Area options

- 3 Click the **Paper Size** pop-up list to select the size of paper you loaded in the printer.

A4 210 × 297 mm

B5 182 × 257 mm

A5 148 × 210 mm

Letter 8 1/2 × 11 in

Legal 8 1/2 × 14 in

Executive 7 1/4 × 10 1/2 in

Half Letter 5 1/2 × 8 1/2 in

A6 Index card 105 × 148 mm

Index card 5 × 8 in

Index card 8 × 10 in

Envelope #10 4 1/8 × 9 1/2 in

Envelope DL 110 × 220 mm

Envelope C6 114 × 162 mm

Envelope 132 × 220 mm

EPSON Photo Paper 4 × 6 in

Panoramic 210 × 594 mm



Note:

The **Rotate by 180°** setting lets you print the lower portion of a document first, with a bottom margin as small as 0.12 inch (3 mm) and a top margin as small as 0.55 inch (14 mm).

When you select **Maximum** as the Printable Area setting, print quality may decrease in the expanded printable area in the bottom margin.

If you don't see the exact size you need, you can create a custom paper size; see [Creating custom paper sizes](#).

- 4 Select the direction of printing on the page with the **Orientation** options. To print your document oriented as shown in one of the following illustrations, select the options listed below it.

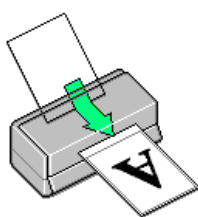

Portrait

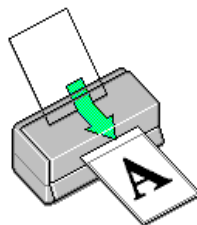

Portrait and
Rotate by 180°

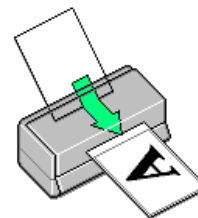

Landscape

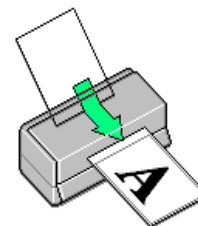

Landscape and
Rotate by 180°

- 5 The **Standard** Printable Area setting uses the maximum printable area of your paper with a minimum bottom margin of 0.55 inch (14 mm). To increase the minimum bottom margin to 0.12 inch (3 mm), set the Printable Area setting to **Maximum**. To center your document on the page using either setting, select the **Centered** checkbox.
- 6 To collate multiple copies of a multi-page document or reverse the order in which pages are printed, see [Selecting Print Order Options](#) for instructions.

If you've finished selecting options, click **OK** to close the Page Setup dialog box. Then select **Print** from the File menu to print your document.

Creating custom paper sizes

You can create up to 8 custom paper sizes and add them to the **Paper Size** list. This is useful if you're printing a custom size document, such as a banner. You can select any width from 3.5 to 9.5 inches, and any height (length) from 3.5 to 44 inches.

Follow these steps to create a custom paper size:

- 1 Open your application's File menu and select **Page Setup**.
- 2 Click the **Customize** button. You see the following dialog box:

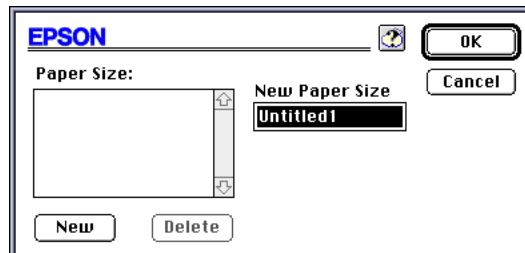

- 3 Click the **New** button. **Width** and **Height** fields and **Inches** and **cm** radio buttons appear on the screen.
- 4 Type the width and length of your custom paper in the **Width** and **Height** fields. If you need to change from inches to centimeters, click the correct radio button.
- 5 Type a name for your paper size in the **New Paper Size** field, then click **OK**. The name is added to the **Paper Size** list and selected as the current setting in the Page Setup dialog box.

- To delete a custom paper size, click the **Customize** button. Then click the name of the custom paper size, and click **Delete**. Click **OK** to return to the Page Setup dialog box.

Selecting Print Order Options

Follow these steps to use the **Collate** and **Reverse Order** options:

- Open your application program's File menu and select **Print**.
- Click the  Layout icon. You see the Layout dialog box:



Note:
For information on the other settings on the Layout dialog box, see [Choosing Print Layout Options on a Macintosh](#).

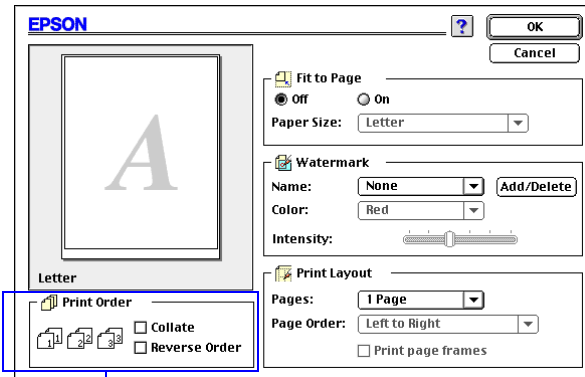

Print Order options

- If you're printing multiple copies of a multi-page document and you want the copies printed in sets, click the **Collate** checkbox. The page graphics change to show collated documents.

- 4 If you're printing a multi-page document and want the last page printed first so the pages come out without needing to be reordered, click the **Reverse Order** checkbox. The page graphics change to show later pages printing first.
- 5 Click **OK** to close the Layout dialog box.

Selecting Print Layout Options



Note:
Layout options are not available with Windows 3.1.

The print layout options let you reduce or enlarge almost any size document to print on your printer. You can also select options to proof multiple pages on one sheet of paper, add page frames, and add a predefined or custom watermark.

Follow the steps in the section for your operating system:

- ▶ [Choosing Print Layout Options in Windows](#)
- ▶ [Choosing Print Layout Options on a Macintosh](#)

Choosing Print Layout Options in Windows

Follow the steps in these sections to use options in the Layout dialog box:

- ▶ [Reducing and Enlarging Your Document Size](#)
- ▶ [Using Multiple Print Layouts and Page Frames](#)
- ▶ [Adding a Watermark](#)

Reducing and Enlarging Your Document Size

When you want to make the printed size of a document different from its actual size, you can use your printer software's **Reduce/Enlarge** settings. You can make the document fit into the printable area on a selected paper size or you can choose to reduce or enlarge it to a selected percentage.

Follow these steps to reduce or enlarge your document size:

- 1 Follow the steps in [Printing from Windows](#) to access the printer settings dialog box, then click the **Paper** tab.
- 2 Click the **Paper Size** list and select the actual size of the document you want to print.

For example, if your document size is 11 × 22 inches, select **US C 11 × 22 in.** This paper size is too large to fit in your printer, so you'll need to proportion it to fit on a **smaller** paper size (by **reducing** the document size). If your document size is 5 × 8 inches, but you want it to fit in the maximum area on Letter-size paper, you'll need to proportion it to fit on a **larger** paper size (by **enlarging** the document size).

- 3 If the **Paper Size** setting you selected for your document is **within** the maximum paper size that can fit on your printer, but you want to **enlarge or reduce** the document, you need to select the reduction/enlargement manually. Go to step 5.

- 4 If the **Paper Size** setting you selected is **larger** than the maximum size that can be printed on your printer, you see the following dialog box:

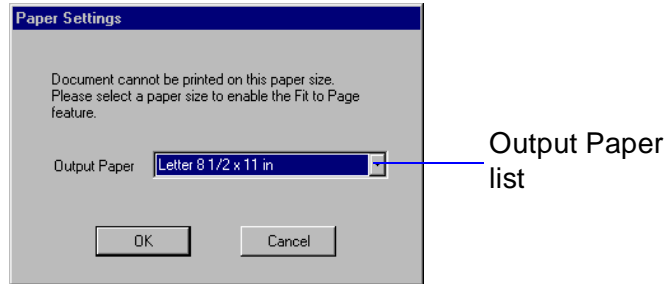

In the **Output Paper** list, select the actual size of the paper loaded in the printer and click **OK**. This automatically turns on the **Fit to Page** setting so the document fits into the printable area on the output paper you select.

The selected **Paper Size**, reduction percentage, and **Output Paper** settings now appear above the printer graphic.

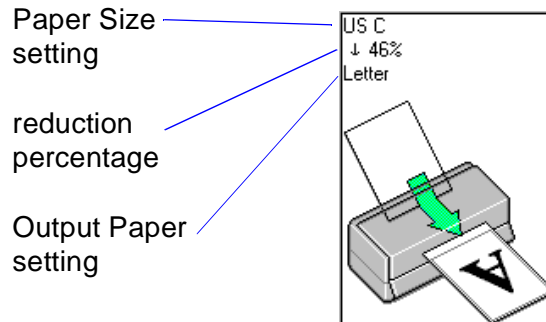

If you want to adjust the proportions or sizes, go to step 5. If you're ready to print, go to step 7.

- 5 Click the **Layout** tab. You see the Layout dialog box:

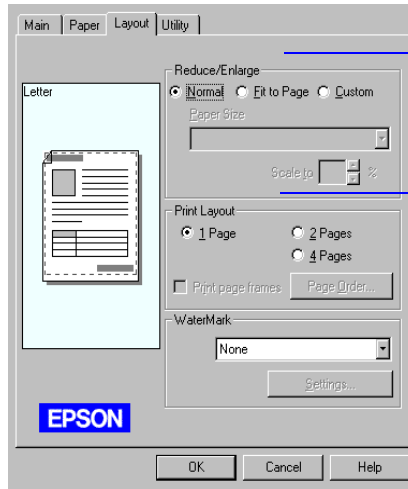

Reduce/Enlarge settings



Note:
If you previously selected a Paper Size setting that is larger than the maximum paper size for your printer and then choose **Normal**, the Paper Size changes to **Letter 8 1/2 x 11 in.**

- 6 Select one of the following **Reduce/Enlarge** settings:
 - ▶ Select **Normal** to set the print proportion to 100%.
 - ▶ Select **Fit to Page** to automatically reduce or enlarge the document to fit on the paper size loaded in the printer. The **Paper Size** option beneath the **Fit to Page** setting becomes active; select the size of paper loaded in the printer.

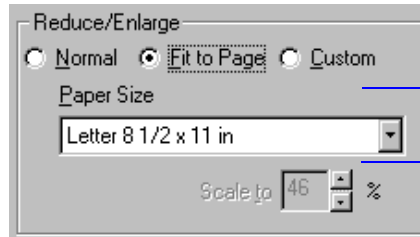

Select **Fit to Page**, then select the size of paper loaded in the printer here

- ▶ Select **Custom**, then select a percentage (10% to 400%) in the **Scale to:** field to reduce or enlarge the document by a specific amount.
- 7 If you're finished selecting Layout options, click **OK**.
If you want to select more options, see [Using Multiple Print Layouts and Page Frames](#).

Using Multiple Print Layouts and Page Frames

If you're printing a multiple page document, but you want a quick proof of the images on each page printed on one piece of paper, you can select Print Layout options in the printer software. You can choose the way the pages are placed on the paper and add a lined frame to each page, if you want.

Follow these steps to use the Print Layout options:

- 1 Follow the steps in [Printing from Windows](#) to access the printer settings dialog box.
- 2 Click the **Layout** tab. You see the Layout dialog box.
- 3 To print multiple pages of your document on one sheet of paper, select either the **2 Pages** or **4 Pages** radio button.

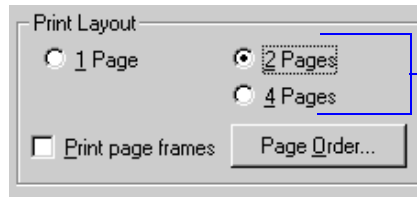

Click a button to select a multiple page print layout

- 4 If the page order of the layout shown in the on-screen graphic is how you want your document printed, go to step 3.

To change the page order, click the **Page Order** button. Then select the page order you want to use from the Print Layout dialog box that appears.



Note:

To add a custom watermark, you must first create the watermark as a bitmap in an application program that can create bitmap files. See your application's documentation for instructions.

If you selected a multiple page print layout option (as described in [Using Multiple Print Layouts and Page Frames](#)), your watermark will appear on each page in the layout.

- 5 If you want to frame each page's contents with a black line, one dot wide, click the **Print page frames** checkbox.
- 6 If you're finished selecting Layout options, click **OK**. If you want to select more options, see [Adding a Watermark](#).

Adding a Watermark

You can add a watermark to each page in your document to emphasize its purpose or indicate how the document should be handled. For example, you may want to add a watermark of the word "Confidential" to documents you don't want distributed to other parties. Or you can add a custom bitmap of your company logo so your document looks like printed letterhead.

Follow these steps to add a watermark:

- 1 Follow the steps in [Printing from Windows](#) to access the printer settings dialog box.
- 2 Click the **Layout** tab. You see the Layout dialog box.
- 3 To select a watermark, click in the **WaterMark** drop-down list.

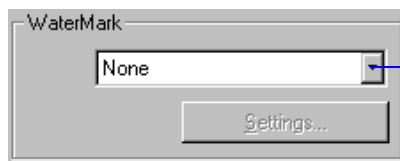

WaterMark drop-down list

Then highlight one of the following watermarks:

Confidential
Draft
Urgent
Priority
Hot

Do Not Copy
For Your Eyes Only
Review Copy
Top Secret
Duplicate

To turn off your watermark, select **None** from the drop-down list.

- 4 To change the watermark or specify how it appears, click the **Settings** button. You see the following dialog box:

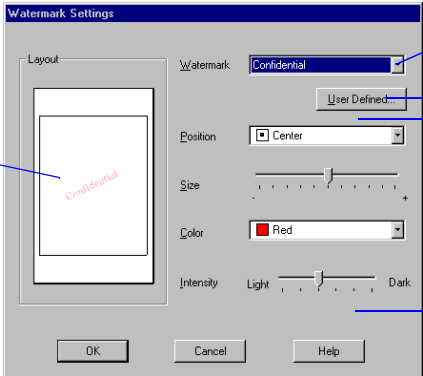

The screenshot shows the 'Watermark Settings' dialog box. On the left, a 'Layout' preview window displays a document with a red 'Confidential' watermark. A blue arrow points from the text 'See how your selections will look in the Layout graphic' to this preview. On the right, the 'Watermark' dropdown menu is set to 'Confidential'. A blue arrow points from the text 'Click here to select a predefined watermark' to this dropdown. Below it is a 'User Defined...' button, with a blue arrow pointing from the text 'Click here to load a custom watermark you've created' to it. Further down are controls for 'Position' (set to 'Center'), 'Size' (a slider), 'Color' (set to 'Red'), and 'Intensity' (a slider from 'Light' to 'Dark'). A blue arrow points from the text 'Specify how you want your watermark to look using these options' to these controls. At the bottom are 'OK', 'Cancel', and 'Help' buttons.

- 5 To load a custom watermark you've created as a bitmap file in an application program, click the **User Defined** button.



Note:

You can create up to 10 custom watermarks. In Windows 95 and 98, you can use any bitmap file up to 15MB in size. With Windows NT, the file can be any size.

To delete a custom watermark from the list, click the **User Defined** button, select the watermark, and click **Delete**.

You see the following dialog box:

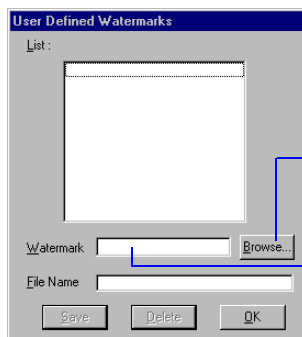

Click Browse to select your bitmap file

Then type a name for your custom watermark here and click Save

Click the **Browse** button. You see a file selection dialog box. Navigate to the folder containing the bitmap file you want to use, select the file, and click **OK**.

Type a name for the custom watermark (up to 24 characters long) in the **Watermark** field. Click the **Save** button to add it to the list, then click **OK**.

The custom watermark now appears as the selected watermark in the Watermark Settings dialog box and is shown in the on-screen graphic.



Note:
If your monitor displays only 16 colors, the Intensity adjustments are not shown in the Layout graphic. If you choose the No Halftoning setting, the Intensity setting does not determine how your watermark is printed.

- 6 Now select the way you want the watermark to appear by choosing the following options. The on-screen graphic changes to reflect all the settings you choose.
 - ▶ **Position** selects where you want the watermark to appear on your page: **Center**, **Top-Left**, **Top-Center**, **Top-Right**, **Left**, **Right**, **Bottom-Left**, **Bottom-Center**, or **Bottom-Right**.
 - ▶ **Size** adjusts the size of the watermark, either larger or smaller, as you move the slide bar.
 - ▶ **Color** lets you choose a color for your predefined watermark: **Red**, **Black**, **Blue**, **Aqua**, **Lime**, **Fuchsia**, or **Yellow**. You cannot select a color for a custom watermark; it is printed in its original colors.
 - ▶ **Intensity** sets the lightness or darkness of the watermark (from 5% to 100%) based on where you move the slide bar.
- 7 If you're finished changing Layout options, click **OK** to close the Layout dialog box.

Choosing Print Layout Options on a Macintosh

Follow the steps in these sections to use options in the Layout dialog box:

- ▶ [Using the Fit to Page Option](#)
- ▶ [Using Multiple Print Layouts and Page Frames](#)
- ▶ [Adding a Watermark](#)

Using the Fit to Page Option

When you want to make the printed size of a document different from its actual size, you can use your printer software's **Fit to Page** option to proportion it to fit in the maximum, centered area on a selected paper size.

Follow these steps to use the Fit to Page option:

- 1 Create your image or document in your application software.
- 2 Open the File menu and select **Page Setup**. You see the Page Setup dialog box.
- 3 Click the **Paper Size** list and select the actual size of the document you want to print. For example, if your **document** size is 8 1/2 x 11 inches, select **Letter** for the Paper Size option.

If you want to print this document on 4 × 6-inch EPSON Photo Paper, you'll use the **Fit to Page** setting to **reduce** the document to that size. If you want to print this document on Legal-size paper (8 1/2 × 14 inches), you'll use the **Fit to Page** setting to **enlarge** the document to that size.

- 4 Click **OK** to close the Page Setup dialog box.
- 5 Now open the File menu and select **Print**. You see the printer settings dialog box.
- 6 Click the  Layout icon. You see the Layout dialog box:

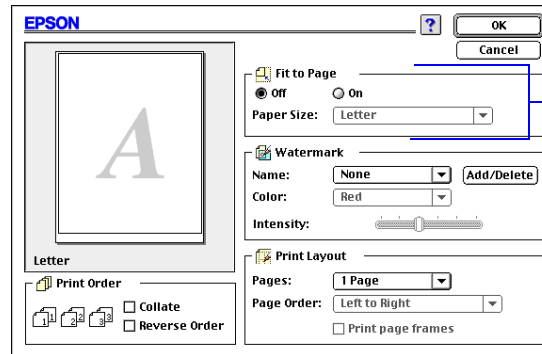

Fit to Page settings

- 7 Select one of the following **Fit to Page** options:
 - ▶ Select **Off** to set the print proportion to 100%.
 - ▶ Select **On** to automatically reduce or enlarge the document to fit on the paper size loaded in the printer.

The **Paper Size** option beneath the **Fit to Page** setting becomes active.

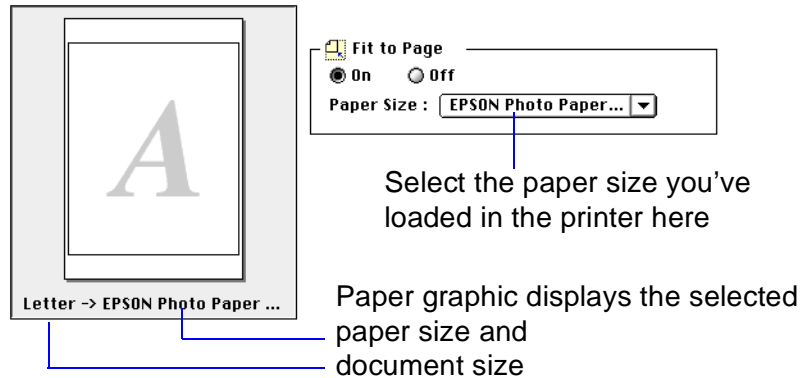

Now select the size of the paper you've loaded in the printer. This automatically sets the correct reduction or enlargement percentage to fit the document into the printable area on the selected paper size. The selected document size and paper size settings now appear beneath the paper graphic.

8 If you're finished selecting Layout options, click **OK**.

If you want to select more options, see [Using Multiple Print Layouts and Page Frames](#).

Using Multiple Print Layouts and Page Frames

If you're printing a multiple page document and you want a quick proof of the images on each page printed on one piece of paper, you can select **Print Layout** options in the printer software. You can choose the way the pages are placed on the paper and add a lined frame to each page, if you want.

Follow these steps to use the Print Layout options:

- 1 Open an application and select a document to print.
- 2 Open the File menu and click **Print**. You see the printer settings dialog box.
- 3 Click the  Layout button. You see the Layout dialog box.
- 4 To print multiple pages of your document on one sheet of paper, select either **2 Pages** or **4 Pages** in the Pages pop-up list.

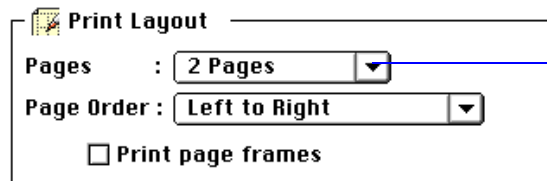

Click the arrow and select a multiple page print layout

- 5 If the page order of the layout shown in the printer graphic is how you want your document printed, go to step 6.

To change the page order, click the arrow in the **Page Order** pop-up list. Then select the page order you want to use.



Note:

To add a custom watermark, you must first create the watermark as a PICT file in an application program that can create PICT files. See your application's documentation for instructions.

If you selected a multiple page print layout option (as described in [Using Multiple Print Layouts and Page Frames](#)), your watermark will appear on each page in the layout.

- 6 If you want to frame each page's contents with a black line, one dot wide, click the **Print page frames** checkbox.
- 7 If you're finished selecting Layout options, click **OK**. If you want to select more options, see [Adding a Watermark](#).

Adding a Watermark

You can add a watermark to each page in your document to emphasize its purpose or indicate how the document should be handled. For example, you may want to add a watermark of the word "Confidential" to documents you don't want distributed to other parties. Or you can add a custom PICT file of your company logo so your document looks like printed letterhead.

- 1 Open an application and select a document to print.
- 2 Open the File menu and click **Print**.
- 3 In the printer settings dialog box, click the  Layout button. You see the Layout dialog box.
- 4 To use one of the predefined watermarks, click the arrow in the **Name** list in the Watermark box and choose one of these:

Confidential
Draft
Urgent
Priority
Hot

Do Not Copy
For Your Eyes Only
Review Copy
Top Secret
Duplicate

Go to step 6.



Note:

You can create up to 10 custom watermarks from PICT files up to 1MB in size.

To delete a custom watermark from the list, click the **Add/Delete** button, select the watermark, and click **Delete**.

- 5 To load a custom watermark you've created as a PICT file in an application program, click the **Add/Delete** button. You see the following dialog box:

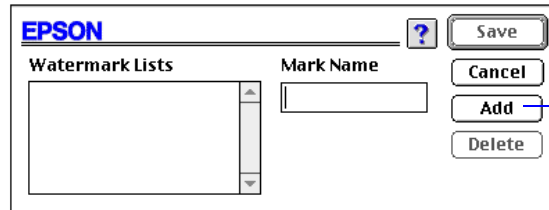

Click the Add button to select a PICT file

Click the **Add** button. You see a dialog box for selecting files. Navigate to the folder containing the PICT file you want to use, select the file, and click **Open**.

The name of your PICT file appears in the **Mark Name** field and is added to the Watermark List. Click the **Save** button to close the dialog box.

The custom watermark now appears as the selected watermark in the Layout dialog box and is shown in the layout graphic.

- 6 Now select the way you want the watermark to appear by choosing the following options. The layout graphic changes to reflect all the settings you choose.
 - ▶ **Color** lets you choose a color for your predefined watermark: **Red, Black, Blue, Aqua, Lime, Fuchsia, or Yellow**. You cannot select a color for a custom watermark; it is printed in its original colors.



Note:

If your monitor displays only 16 colors, the Intensity adjustments are not shown in the Layout graphic. If you choose the No Halftoning setting, the Intensity setting does not determine how your watermark is printed.

- ▶ **Intensity** sets the lightness or darkness of the watermark (from 5% to 100%) based on where you move the slider.
- ▶ To adjust the size and position of the watermark, move the cursor over the Layout graphic. Four boxes appear in the corners of the graphic and the cursor changes to a hand.

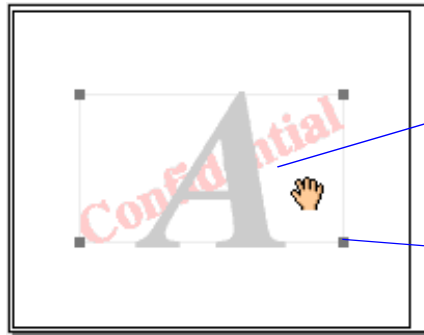

Click and drag anywhere in here to move the watermark

Click and drag one of the corner boxes to resize the watermark

To move the watermark, click anywhere inside the graphic and drag it into one of these positions: center, top-center, upper-right, middle-right, lower-right, bottom-center, upper-left, middle-left, or lower-left.

To resize the watermark, move the cursor over one of the corner boxes; the cursor changes to a pointing hand. Click and drag the box corner to reduce or enlarge the watermark.

- 7 If you're finished changing Layout options, click **OK** to close the Layout dialog box.

Using Print Preview on the Macintosh



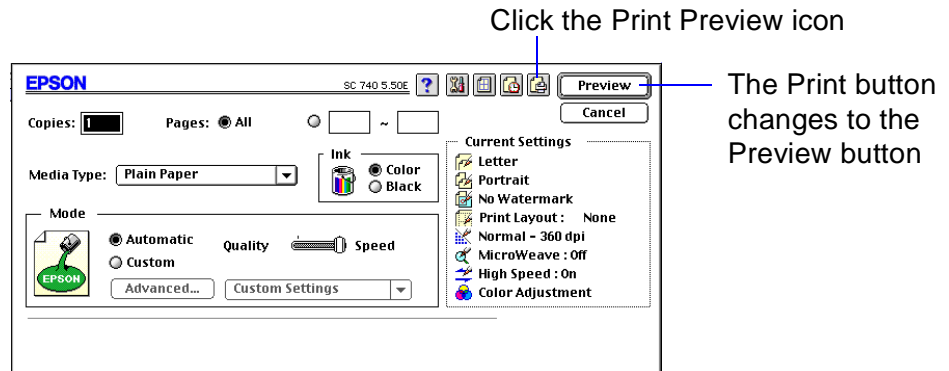

You can get a preview of how your document will print with the Print Preview feature in your Macintosh printer software. Print Preview shows the results of the following printer software settings on your document:

- ▶ Print layout settings such as **Fit to Page**, **Page Order**, **Watermark**, **Reverse Order**, and **Collate**
 - ▶ Page Setup options, such as **Paper Size**, **Orientation**, **Rotate by 180°**, and **Printable Area**
- 1 Open an application and select a document to print.
 - 2 Open the File menu and click **Print**. You see the printer settings dialog box.

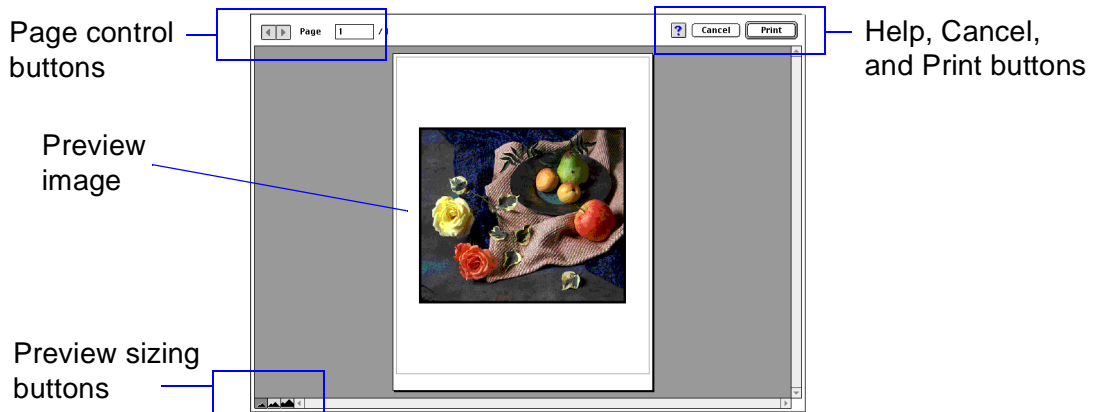

- 3 Click the  Print Preview icon. The **Print** button changes to the **Preview** button.
- 4 Click the **Preview** button. You see the print preview dialog box:



- 5 The first preview page is the first page of your document. To change the preview page, click the  or  button to go back or forward one page, or enter a page number in the **Page** field.
- 6 To change the size of the preview, click the following buttons:
 - ▶ Click  to preview the entire page in the display area
 - ▶ Click  to enlarge the preview
 - ▶ Click  to enlarge the preview even further
- 7 To print your document, click **Print**. To close the print preview dialog box and return to your application, click **Cancel**.

Saving Custom Settings

After you've fine-tuned your printer settings for a special project, you can save the settings as a group. Then you can quickly reuse them the next time you print a similar project. You can save up to 10 (Windows) or 8 (Macintosh) groups of settings.

- 1 Customize your printer settings, then access the Advanced dialog box as described in [Customizing Print Quality and Special Effects](#).

(In Windows 3.1, access the main printer settings dialog box as described in [Printing from Windows](#), then click **Advanced**.)

- 2 Click the **Save Settings** button. You see this dialog box:

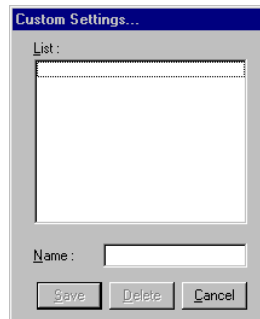

Windows

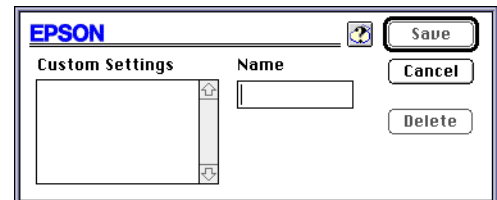

Macintosh

- 3 Type a unique name for your settings (up to 16 characters) and click the **Save** button.

- 4 Click **OK** to close the Advanced dialog box (not necessary with Windows 3.1).

To use the settings, click **Custom** (in Windows 3.1, click **Advanced**). Then open the Custom Settings list and double-click the name you selected for your custom settings group. (On a Macintosh, the custom settings group is automatically selected.)

To redefine or delete your custom settings, see [Redefining Custom Settings](#) or [Deleting Custom Settings](#).

Redefining Custom Settings

To change the options in a customized settings group but keep the same name for it, follow these steps:

- 1 From the main printer settings dialog box, click **Custom** (in Windows 3.1, click **Advanced**). Then select the name of the custom settings group you want to redefine in the Custom Settings list.
- 2 Click the **Advanced** button (in Windows 3.1, click **More Settings**) and change the printer settings. (If you change the **Media Type** and **Ink** settings, you'll need to create a new custom setting group instead of redefining an existing one.)
- 3 When you're finished redefining settings, click **Save Settings**. (In Windows 3.1, click **OK** to close the More Settings dialog box and the click **Save Settings** on the main printer settings dialog box.)

- 4 Select the name of the custom settings group you're redefining in the Custom Settings dialog box.
- 5 If you're using Windows, click **Save**. You see the Save As dialog box. Click **OK** to save your redefined settings. (Click **Cancel** to cancel your changes.)

On a Macintosh, click the **Redefine** button. Then click **Replace** at the confirmation dialog box to save your redefined settings. (Click **Cancel** to cancel your changes.)

Deleting Custom Settings

- 1 From the main printer settings dialog box, click **Custom**, then click the **Advanced** button. Click **Save Settings** on the Advanced dialog box. (In Windows 3.1, click **Advanced**, then click **Save Settings** on the main printer settings dialog box.)
- 2 Select the custom settings group in the Custom Settings box, and click **Delete**. Then click **OK** to confirm the deletion, if necessary. (You cannot delete any of the predefined document types.)

Printing on Special Media

Your EPSON Stylus COLOR 740i lets you print on just about any kind of paper you want to use. You can get great results printing on various sizes of plain paper, letterhead, and envelopes, but you'll get even better results with specially coated ink jet paper.

For the best output, use EPSON's photo-quality paper: ink jet paper, glossy paper, glossy film, note cards, and photo paper. For special projects, you can use a variety of EPSON media designed for ink jet printers, ranging from transparencies to iron-on transfer paper.

Follow the steps in this chapter on:

- ▶ [Selecting Special Media](#)
- ▶ [Media Loading and Handling Guidelines](#)

Selecting Special Media

When you print on special media, you need to choose the correct **Media Type** and **Paper Size** settings in your printer software. The table below lists the available EPSON media and the corresponding **Media Type** setting for each one.

Media name	Size	Part number	Media Type setting
EPSON 360 dpi Ink Jet Paper	Letter A4	S041060 S041059	360 dpi Ink Jet Paper
EPSON Iron-On Cool Peel Transfer Paper	Letter	S041153/S041155	
EPSON High Quality Ink Jet Paper	Letter A4	S041111 S041117	Photo Quality Ink Jet Paper
EPSON Photo Quality Ink Jet Paper	Letter A4 Legal	S041062 S041061 S041067	
EPSON Photo Quality Ink Jet Cards	A6 8 × 10 inches	S041054 S041122	
EPSON Photo Quality Self Adhesive Sheets	A4	S041106	

Media name	Size	Part number	Media Type setting
EPSON Photo Quality Glossy Paper	Letter A4	S041124 S041126	Photo Paper
EPSON Photo Paper	4 × 6 inches Letter A4 Panoramic	S041134 S041141 S041140 S041145	
EPSON Photo Quality Glossy Film	Letter A4 A6	S041072 S041071 S041107	Photo Quality Glossy Film
EPSON Photo Stickers Kit (CD-ROM and paper) EPSON Photo Stickers (refill)	A6 A6	S041144-KIT S041144	
EPSON Ink Jet Transparencies	Letter A4	S041064 S041063	Ink Jet Transparencies

To order EPSON papers and other media, contact your dealer or call EPSON Accessories at (800) 873-7766 or visit our web site at www.epsonsupplies.com (U.S. sales only). In Canada, please call (800) 873-7766 for dealer referral.



Caution:
Don't use the cleaning sheets that may be included with your special media; they may jam inside the printer.

Media Loading and Handling Guidelines

The following tips help you get the best results on any type of paper:

- ▶ Always handle sheets by the edges, and don't touch the printable surface.
- ▶ When you load paper, make sure the printable side is facing up.
- ▶ You can load paper up to the arrow mark on the left edge guide.
- ▶ Return unused sheets and envelopes to their original package as soon as possible. See [Paper](#) for more storage information.
- ▶ If your paper package included protective sheets, cover the printed side of your paper with these sheets before stacking your paper.
- ▶ Use ink jet papers within one year of purchase. Use glossy media and transparencies within six months.
- ▶ Follow any specific instructions for your paper in the following sections:
 - ▶ [Letterhead, Preprinted Forms, and Legal-size Paper](#)
 - ▶ [EPSON Photo Quality Glossy Paper, Film, and Transparencies](#)
 - ▶ [Envelopes](#)

- ▶ [EPSON Photo Paper](#)
- ▶ [EPSON Photo Quality Ink Jet Cards](#)
- ▶ [EPSON Photo Stickers](#)
- ▶ [EPSON Photo Quality Self Adhesive Sheets](#)
- ▶ [EPSON Iron-On Cool Peel Transfer Paper](#)

Letterhead, Preprinted Forms, and Legal-size Paper

Load the top edge first. When you load long paper, pull up the paper support extension and both output tray extensions.

EPSON Photo Quality Glossy Paper, Film, and Transparencies

Before you load glossy film or transparencies, put a support sheet (packed with the media) or a plain paper sheet beneath the stack. (Don't use a support sheet with Photo Quality Glossy Paper.)

You can load up to 20 sheets of glossy paper or glossy film, or up to 30 transparencies.

On Photo Quality Glossy Film, you may get better results by loading one sheet at a time. With multiple sheets loaded, the minimum top margin you can use is 1.2 inches (30 mm). If you want to use a smaller top margin, load and print one sheet at a time.



Note:

It is best not to use the **Maximum** printable area setting in the printer software when printing on paper with a cut corner. Part of your document may print in the cut out area.

If your media has a cut corner, position it in the printer as shown here.

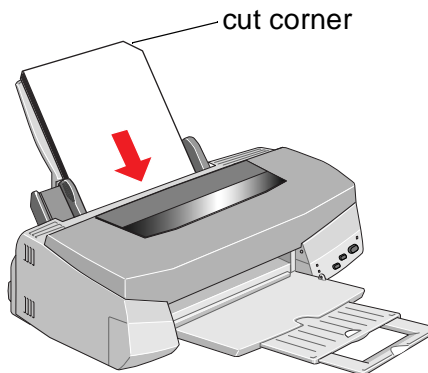

Remove each sheet from the output tray immediately after it's printed. Make sure each sheet is dry before stacking.



Note:

If the stack of envelopes is more than 0.4-inch (10 mm) thick, press the envelope edges to flatten them before stacking or load one envelope at a time.

Envelopes

You can load up to 10 envelopes flap edge first, with the printable side up, as shown:

Select **Plain paper** as the Media Type and choose the correct envelope size as the Paper Size setting in the printer software.

If ink smears when you print on envelopes or other thick media, set the paper thickness lever to the **+** position as shown. (Return the lever to the **0** position before printing on other media.)

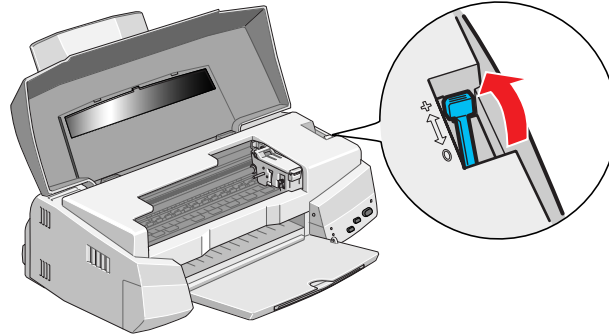
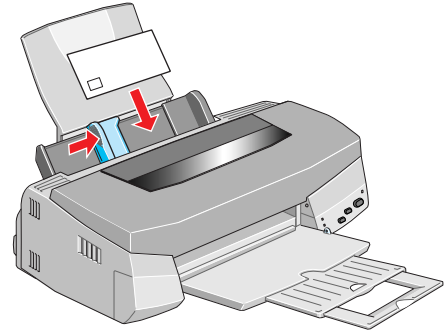

EPSON Photo Paper

You can use EPSON Photo Paper to print photographs that look almost as good as the ones you get from film processing. 4 × 6-inch Photo Paper is perforated around the edges, so you can trim your printouts and “bleed” the photo—extend it to the edge of the paper—on all sides.

You can load up to 20 sheets of 4 × 6-inch, Letter-size, or A4-size Photo Paper or 1 sheet of Panoramic paper at a time. Make sure you place a support sheet beneath the paper if it is included in the paper package.

Keep the following in mind when using EPSON Photo Paper:

- ▶ Load the paper with the whiter (glossier) side facing up.
- ▶ If you’re loading Panoramic Photo Paper, pull up the paper support extension. Then load the Panoramic paper and hold up its top edge while you press the  load/eject button to feed it into the printer.

Select **Photo Paper** as the Media Type setting and **Panoramic 210 × 594 mm** as the Paper Size setting.



Note:

To keep your printouts looking their best, store them in a resealable plastic bag or other airtight covering and protect them from heat, humidity, and direct sunlight.

Be sure to support your Panoramic Photo Paper as it ejects from the printer so it doesn’t fall onto the floor.

- ▶ If you're loading 4 × 6-inch Photo Paper, follow these steps:
 - 1 Position the perforated margins as shown and load up to 20 sheets with support sheets A and B beneath the stack.

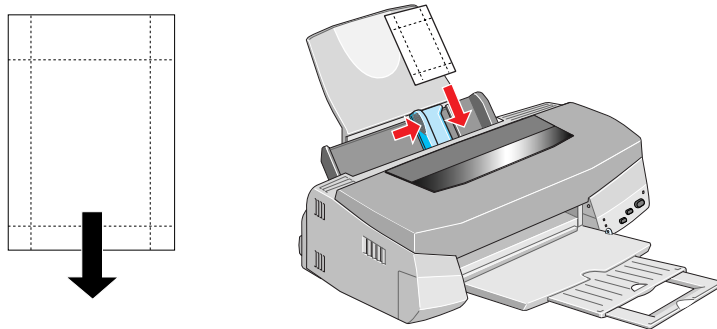

- 2 When you create the image you'll print in your application software, size it to 4.25 × 6.25 inches so the image covers the perforations as shown.

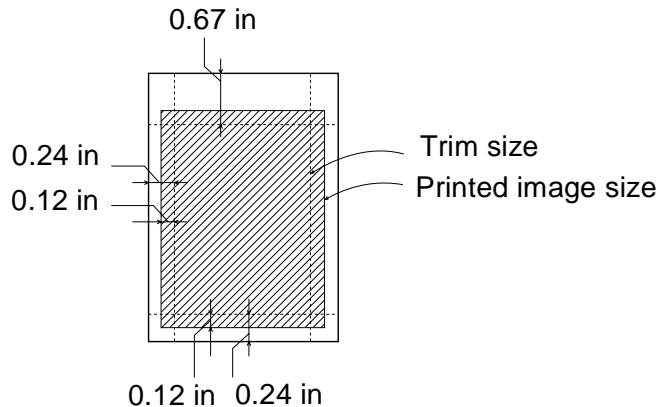



You can use 4 × 6-inch EPSON Photo Paper like a postcard. After printing on the glossy side of the Photo Paper, let your image dry completely. Then set the paper thickness lever to the + position, reload the flattened card with the uncoated side up, and print your message in black ink using **360 dpi Ink Jet Paper** as the Media Type setting.

- 3 Choose these printer software settings:

Photo Paper as the Media Type setting
EPSON Photo Paper 4 × 6 in as the Paper Size setting
Maximum as the Printable Area setting

- 4 After you print, fold the paper back and forth along the perforations and carefully tear the margins off.

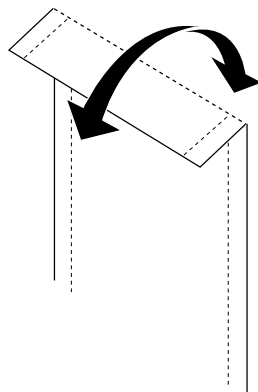

EPSON Photo Quality Ink Jet Cards

You can load up to 30 cards at a time. Always place the included support sheet under the cards and load them as shown below.

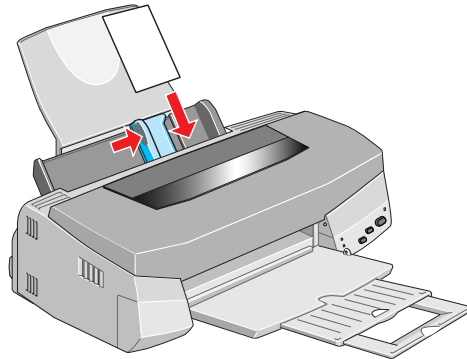

Make sure you set the paper thickness lever to the **+** position as shown in [Envelopes](#). When you're ready to print, set the Media Type to **Photo Quality Ink Jet Paper** and the **Paper Size** setting to the card size in your printer software.

EPSON Photo Stickers

Use these sheets of stickers to print small, decorated photos for use on cards, invitations, or other items. You'll need to use an application that can create photo stickers, such as StickerPix.™

Load one sheet of Photo Stickers at a time. Make sure to place support sheets A and B that came with the stickers beneath the sheet.

When you're ready to print, select **Photo Quality Glossy Film** as the Media Type setting and **A6 Index card 105 × 148 mm** as the Paper Size in your printer software.

EPSON Photo Quality Self Adhesive Sheets

Use these sheets to print labels or stickers. You can load one sheet at a time. Make sure your adhesive sheets are fully adhered to their backing sheet before you load them.

When you're ready to print, select **Photo Quality Ink Jet Paper** as the Media Type setting in your printer software.

EPSON Iron-On Cool Peel Transfer Paper

You can print photos, company logos, or anything else you want on these transfer papers, and then iron your images onto T-shirts or other cloth items.

Load one sheet of transfer paper at a time. Select **360 dpi Ink Jet Paper** as the **Media Type** setting.

Make sure you reverse your image before you print it—especially if it includes text—so it will read correctly when it's transferred. You can use the **Flip Horizontal** setting in your printer software to do this (see [Customizing Print Quality and Special Effects](#) for instructions).

After you print, follow the instructions that came with the paper to iron the image onto the shirt or other item.

Managing Print Jobs

Your printer software includes several utilities for managing print jobs. You can use them to monitor your printer's status and check on the current print job or jobs waiting to print.

This chapter provides instructions for the following:

- ▶ [Managing Print Jobs in Windows 95, Windows 98, and Windows NT 4.0](#)
- ▶ [Managing Print Jobs in Windows 3.1](#)
- ▶ [Managing Print Jobs on a Macintosh](#)



Windows NT 4.0 servers and workstations include a messenger service to alert you to printer errors or let you know when a print job is finished. If you have appropriate network access privileges or you're controlling printing from the server, you can also set other options. See your Windows NT documentation for details.

Managing Print Jobs in Windows 95, Windows 98, and Windows NT 4.0

Your printer software offers three ways to manage and monitor your print jobs:

- ▶ Progress Meter, which appears each time you send a print job, as described in [Checking Printer Status](#). You can turn the Progress Meter on or off and select other printing options using the **Speed & Progress** button; see [Selecting the Speed & Progress Options](#) for details.
- ▶ Spool Manager (not available with Windows NT), which appears in the taskbar at the bottom of the screen each time you print, as described in [Using the Spool Manager](#).
- ▶ Status Monitor 2, which provides a variety of print monitoring options, as described in [Using Status Monitor 2](#).

Selecting the Speed & Progress Options

You can set up the way your printer software sends print jobs and displays the Progress Meter using the **Speed and Progress** dialog box. To access the dialog box, you must open your printer software from the Windows Printers utility as described below.

- 1 Click **Start**, point to **Settings**, then click **Printers**.
- 2 Right-click the **EPSON Stylus COLOR 740** printer icon and select **Properties** (Windows 95 and 98) or **Document Defaults** (Windows NT) from the menu.
- 3 Click the **Utility** tab. You see the Utility menu:

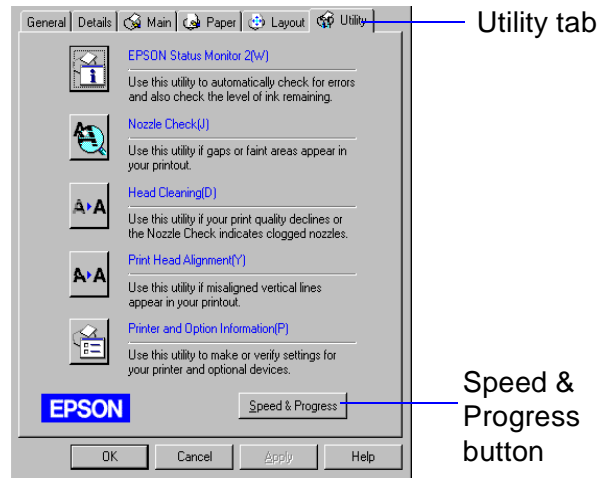

- 4 Click the **Speed & Progress** button.

You see this dialog box:

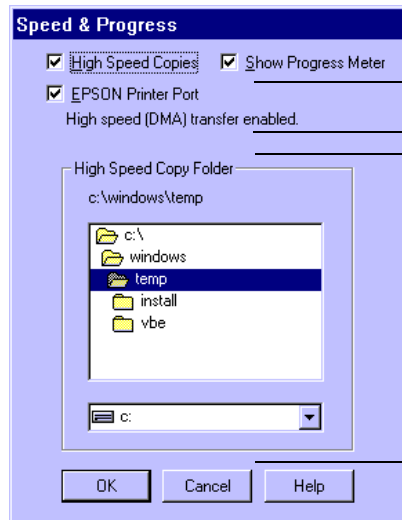

Not available with Windows NT

If you have more than one hard disk drive, you can select a folder for storing multiple copy print jobs here. You don't see this box if you have only one hard disk drive.

Select the following options:

- **High Speed Copies** speeds up printing of multiple copies of the same document using hard disk space as a cache.
- **Show Progress Meter** lets you control whether or not the Progress Meter is displayed when you send a print job. See [Checking Printer Status](#) for information on the Progress Meter.

- ▶ **EPSON Printer Port** (not available with Windows NT 4.0) lets you optimize the transfer rate of your printer port for EPSON printers instead of using the Windows default printer port. You may see one of these messages beneath the **EPSON Printer Port** option:
 - ▶ **High speed (DMA) transfer enabled** tells you that you're already using fast DMA transfer mode.
 - ▶ **For higher data transfer rates, use DMA transfer** lets you know that you can speed up printing by enabling DMA transfers on your system. See your computer documentation or contact your computer's technical support for instructions on using DMA transfers, if your computer supports them.

If you see no message, you cannot enable DMA transfers on your system.

- 5 Click **OK** to close the Speed & Progress dialog box and return to the Utility menu. Then click **OK** again to exit your printer software.

Using the Spool Manager

The Spool Manager (not available with Windows NT) creates a temporary print job file and stores it in the C:\TEMP or C:\WINDOWS\TEMP folder. The software then sends the file to your printer at the right time.

To open Spool Manager while you're printing, click the **EPSON Stylus COLOR 740** button that appears on the taskbar at the bottom of the screen. You see the Spool Manager window:

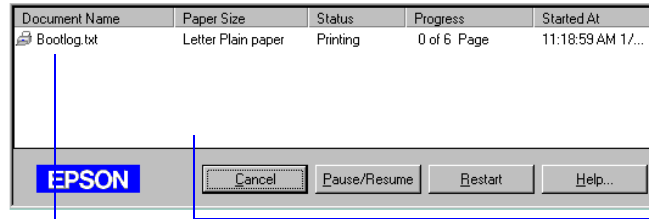

Print job file

Command buttons

The Spool Manager window displays the status of your print job files and lets you control them. To cancel, pause, resume, or restart a print job, click the job to highlight it; then click the corresponding command button on the bottom of the window.

Deleting a Stalled Print Job

If you're having trouble printing, it may be because of a stalled print job. Follow these steps to delete it and continue printing:

- 1 Click the **EPSON Stylus COLOR 740** button on the taskbar.
- 2 Click on any print jobs marked **Held**.
- 3 Click the **Cancel** button.
- 4 Exit Spool Manager and try printing again.



Note:

You can check printer status using Status Monitor 2 only when your printer is connected directly to your computer on a bidirectional port.

Using Status Monitor 2

Status Monitor 2 lets you view detailed information about your print jobs and control how you want printing monitored. Before you can use Status Monitor 2, you must enable background monitoring for your printer if it isn't already enabled.

Follow the instructions in these sections:

- ▶ [Enabling Background Monitoring](#)
- ▶ [Setting Up Monitoring Preferences](#)
- ▶ [Using the Status Monitor 2 Main Window](#)
- ▶ [Using the Printer Status Window](#)
- ▶ [Using the Job Status Window](#)

Enabling Background Monitoring

To turn on background monitoring, follow these steps:

- 1 Click **Start**, point to **Programs**, click the **Epson** folder, and click **EPSON Status Monitor 2**.
- 2 Click **EPSON Stylus COLOR 740** in the Printer Name list. The name is highlighted.
- 3 Open the Settings menu and select **Background Monitoring**.
- 4 Select either **Monitor from restart** (to begin background monitoring after your next system restart) or **Monitor now** (to begin background monitoring right away).
- 5 Now set your monitoring preferences for the printer as described in [Setting Up Monitoring Preferences](#).



Note:
Background monitoring must be turned on to change the Background Monitoring and Status Alert preferences. See [Enabling Background Monitoring](#) for instructions.

Setting Up Monitoring Preferences

You can select the way you want Status Monitor 2 to monitor your printer using the Monitoring Preferences window. There are several ways to open the window:

- ▶ Click the printer name in the Installed Printers list to highlight it and click the  icon or select **Monitoring Preferences** from the Settings menu.
- ▶ Right-click the printer name in the Installed Printers list and select **Monitoring Preferences** from the drop-down menu.

You see the Monitoring Preferences window:

Turn background monitoring on or off for the selected printer

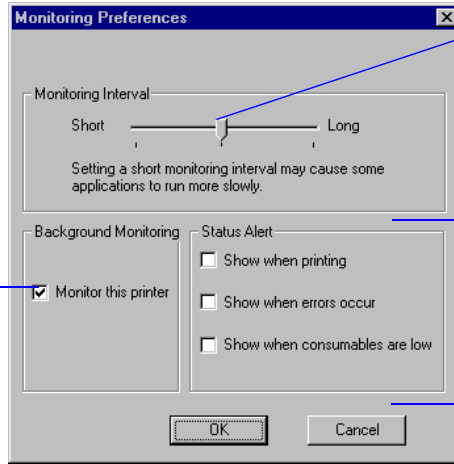

Set the length of the interval in which you want Status Monitor 2 to monitor your printer here (short intervals may cause some applications to run slower)

Select if and when to use the Status Alert dialog box: while printing, when errors occur, and/or when ink is low

If you turn on one or more of the Status Alert options, you'll see the Status Alert dialog box when the selected condition occurs. For example, if you turn on **Show when errors occur**, the dialog box appears only if a printing error occurs. If you select all the options, the dialog box appears whenever you print, encounter an error, or have low ink levels.

The color of the printer icon in the Status Alert dialog box indicates the type of error, as described in [Interpreting the Installed Printer icon](#).

Click the printer name to highlight it, then click **Details** to open the Printer Status window; see [Using the Printer Status Window](#) for more information

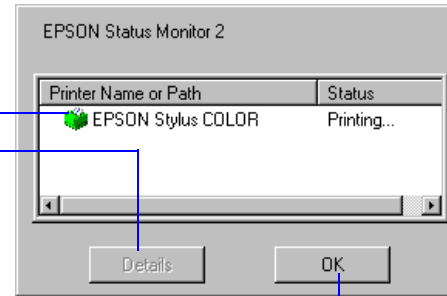

Click here to close the Status Alert dialog box

Using the Status Monitor 2 Main Window

Once you've enabled background monitoring for your printer and set up your monitoring preferences, there are two ways to access Status Monitor 2:

- ▶ Double-click the  icon on the taskbar in the bottom right corner of your screen.
- ▶ Click **Start**, point to **Programs**, click the **Epson** folder, and click **EPSON Status Monitor 2**.

When you start Status Monitor 2, you see the main window:

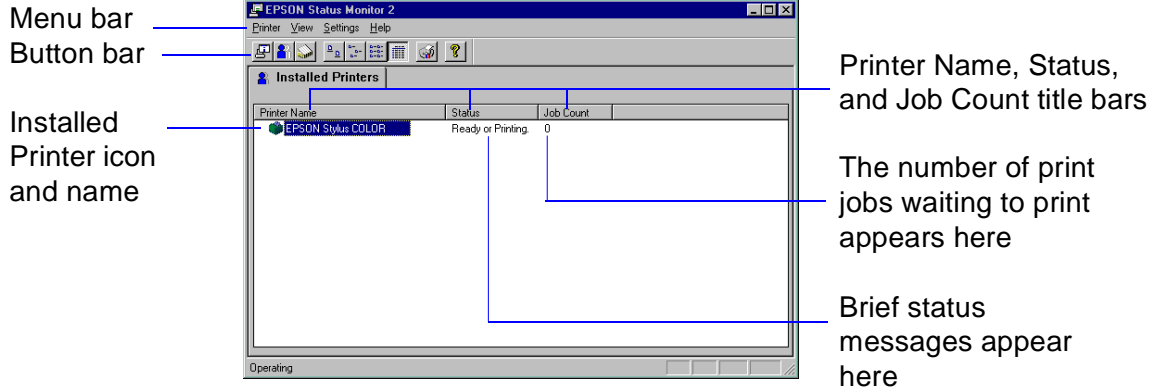

You can change the shape of the Status Monitor 2 printer icon by clicking the **Select background monitoring** icon in the Settings menu and selecting the icon you want to use.

If you have more than one printer you want to monitor, you can add them using the **Add Printers** option in the Settings menu. To save system resources, you may want to delete any printers from the Status Monitor 2 list that you don't need to monitor. To do this, click the printer in the Installed Printers list and select **Delete Printer** from the Settings menu.

You can customize the appearance of items on the Status Monitor 2 main window using the View menu options or using icons on the button bar. If you're monitoring multiple printers, you can reorder them in the Installed Printers list by clicking in the Printer Name, Status, or Job Count title bar.

Other options in Status Monitor 2 let you view more details on the printer or job status, as described in [Using the Printer Status Window](#) and [Using the Job Status Window](#).

Interpreting the Installed Printer icon

The color of the Installed Printer icon indicates the printer status as follows:

Installed Printer icon color	Status message
Green	Ready to print
Yellow	Paper and/or ink level is low
Red	Paper and/or ink is out, paper is jammed, or a print error has occurred
Gray or dimmed	A communication error has occurred (check your cable connections)

Using the Printer Status Window

For more details on the status of your printer, you can use the Printer Status window. There are several ways to open the window:

- ▶ Double-click the printer name in the Installed Printers list.
- ▶ Click the printer name in the Installed Printers list to highlight it and click the  icon or select **Printer Status** from the Printer menu.

- ▶ Right-click the printer name in the Installed Printers list and select **Printer Status** from the drop-down menu.
- ▶ If you're currently using the printer software, click the **Utility** tab, then click the **EPSON Status Monitor 2** icon.
- ▶ You can also access the Printer Status window by clicking the **Details** button on the Progress Meter (see [Checking Printer Status](#)) or the Status Alert dialog box (see [Setting Up Monitoring Preferences](#)).

You see the Printer Status window. The Current Status tab gives printing status and error correction information.

Illustrations of what to do if an error occurs appear here



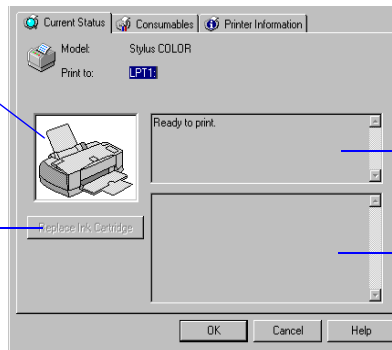

If your printer runs out of ink, click this button to display cartridge replacement steps on the right and illustrations in the printer graphic area

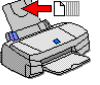

Printer status messages

If an error occurs, troubleshooting tips appear here

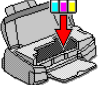
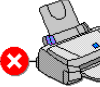
The printer graphic in the Printer Status window gives status and error condition information:

Graphic	Condition
	Ready to print
	Paper isn't loaded correctly
	Paper is jammed
	Black ink is out
	Color ink is out
	A communication error has occurred
	Another type of printer error has occurred

To check the amount of ink you have, click the **Consumables** tab.

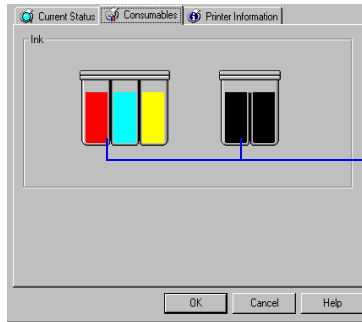

These graphics indicate the amount of ink remaining in your cartridges

(The **Printer Information** tab doesn't display information for your printer.)



Note:
The Job Status window is very similar to the Spool Manager window. Both allow you to pause, cancel, and restart print jobs. See [Using the Spool Manager](#) for more information.

Using the Job Status Window

To view detailed information on the print jobs waiting to print, you can use the Job Status window (not available with Windows NT). There are several ways to open the window:

- ▶ Click the printer name in the Installed Printers list to highlight it and click the  icon or select **Job Status** from the Printer menu.
- ▶ Right-click the printer name in the Installed Printers list and select **Job Status** from the drop-down menu.

You see the Job Status window:

Menu
bar

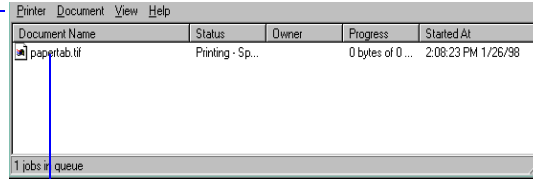

Information on jobs currently printing or waiting to be printed appears here

Options in the Printer menu let you pause printing or purge all waiting print jobs, select or deselect the printer as your Windows default, and access the printer software to change default settings.

The Document menu options let you pause or cancel printing of individual print jobs. First click the print job you want to pause or cancel in the Document Name list to highlight it.

Managing Print Jobs in Windows 3.1

Your Windows printer software includes two management utilities: the Spool Manager and Despooler.

- ▶ The Spool Manager starts automatically when you send a job to the printer. It allows you to print in the background while you continue to work on your computer and to hold jobs to print at a later time. If you're using your printer on a network, it also handles multiple print jobs that come in at the same time. See the next section for details.
- ▶ The Despooler also starts automatically when you send a job to the printer. It displays on your screen to provide printer status information. See [Checking Printer Status](#) for details on the Despooler.

Using the Spool Manager

The Spool Manager works like the Windows Print Manager. When you send a job to your printer, your printer software creates a temporary print job file, stores it in the C:\TEMP or C:\WINDOWS\TEMP directory, and assigns it to a print queue. The software then sends the file to your printer at the right time.



Note:

You may not see the Spool Manager icon if Program Manager or the current window is maximized. Reduce the window size to see the Spool Manager icon.

To open Spool Manager, do one of the following:

- ▶ To open it while you're printing, click the **EPSON Spool Manager** icon at the bottom of your desktop.
- ▶ You can open Spool Manager at any time by double-clicking the **Spool Manager4** icon in the EPSON program group.

You see the Spool Manager window:

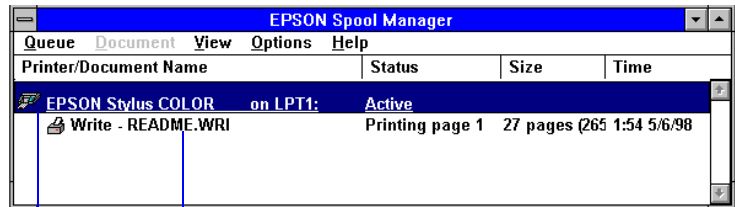

Queue

Print job file

The Spool Manager window displays the status of your print job files and lets you control them. You can also control print queues, display of the Despooler, and the default spool directory. Click **Help** in the Spool Manager menu bar for detailed information.

Deleting a Stalled Print Job

If you're having trouble printing, it may be because of a stalled print job. Follow these steps to delete it and continue printing:

- 1 Open the Spool Manager as described in [Using the Spool Manager](#).
- 2 Click on any print jobs marked **Held**.
- 3 Open the Document menu and click **Delete**. Then click **Yes**.
- 4 Exit Spool Manager and try printing again.

Changing the Default Spool Directory

If you get an error message while printing, or printing is very slow, you can try changing your default spool directory.

- 1 Make a directory on your hard drive where you want Spool Manager to store print job files, for example, C:\SPLTEMP.
- 2 Open the Spool Manager as described in [Using the Spool Manager](#).
- 3 Make sure EPSON Stylus COLOR 740 is selected, and then choose **Setup** from the Queue menu. The Queue Setup dialog box appears.
- 4 Change the spool directory to the one you created in step 1. Also make sure **Use Print Manager for this port** is checked. Then click **OK**.

- 5 Choose **Default Spool Directory** from the Options menu.
- 6 In the dialog box, change the spool directory to the one you created in step 1. Then click **OK**.
- 7 Close Spool Manager.



Note:

You can also select background printing options before you print. See [Setting Up Background Printing Options](#) for more information.

Managing Print Jobs on a Macintosh

Your Macintosh printer software includes two print job management utilities: Monitor3 and Status Monitor. It also includes a Configuration utility for setting up print monitoring options.

- ▶ If you're using background printing, Monitor3 starts automatically when you send a job to the printer. It handles printing while you continue to work on your Macintosh, lets you track documents that are waiting to be printed, and lets you set priorities and print times for waiting print jobs.
- ▶ The Status Monitor alerts you to any problems that occur during printing. You can also use it at any time to see how much ink you have left.
- ▶ The Configuration utility lets you select how you want to be notified of printer errors and where you want print job files stored.

Using Monitor3

The Monitor3 utility lets you continue to work on your Macintosh while your document is printing (however, background printing is slower and may also slow down your system). You can then open the Monitor3 dialog box to check on your print jobs and cancel, pause, or restart them.

To use this utility, you need to turn on background printing and increase the memory allocation for Monitor3, as described in [Setting Up Monitor3](#).



Note:

You can also turn on background printing while you're using your printer software; see [Setting Up Background Printing Options](#) for instructions.

Setting Up Monitor3



- 1 Open the Chooser from the Apple menu and select the **SC 740** icon. Then select the port you're using.
- 2 Under **Background Printing**, click **On** and close the Chooser.
- 3 To increase the memory allocation, select **EPSON Monitor3** in the Extensions folder in your System folder. Then choose **Get Info** from the File menu and set the **Memory Requirements** to 2000 or 3000, depending on your system's available RAM.

Monitoring Print Jobs with Monitor3

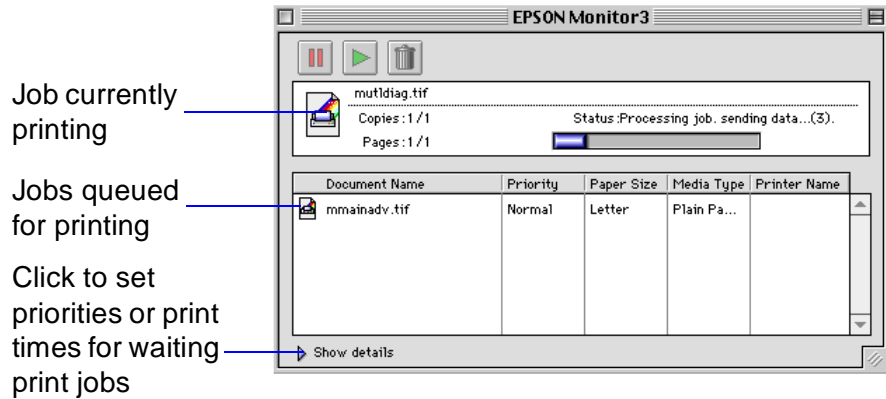
While you're printing, click the **EPSON Monitor3** icon on the Application menu at the right end of the menu bar. You see the following dialog box:



You can track the printer's progress with the current job, or double-click a job and use these command buttons:

- ▶ click  to delete
- ▶ click  to restart
- ▶ click  to pause



Note:

If you see a stop sign icon and the message **Print queue on hold** in the EPSON Monitor3 dialog box, select **Start print queue** from the Printer menu to release the queue and resume printing.

To set priorities for jobs waiting to print, click the job, then click the **Show details** arrow at the bottom of the window.

Priority list box
Settings selected for the highlighted print job

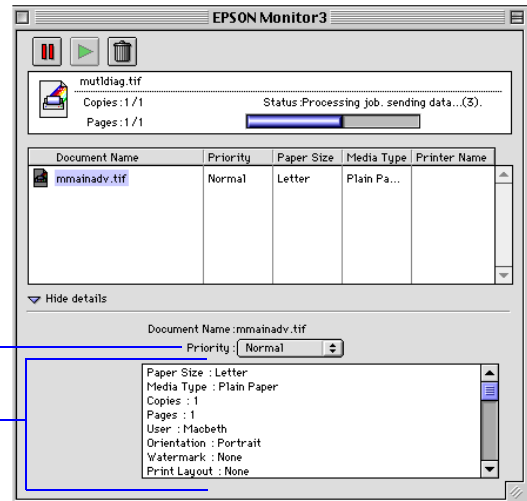

The **Priority** list becomes active. Click the arrow and select one of the following settings:

- ▶ **Normal** prints the job in the order it is received
- ▶ **Urgent** moves the job before any Normal priority jobs in the print queue
- ▶ **Hold** holds the job in the print queue until you're ready to release it for printing by clicking the  restart icon

- ▶ **Print Time** opens the dialog box below so you can set a specific print time; click **OK** after setting the day and time



Using the Macintosh Status Monitor

You can use the Status Monitor to check the level of ink in your printer. Follow these steps:

- 1 Choose **Page Setup** or **Print** from the File menu in your application. You see a printer settings dialog box.
- 2 Click the  Utility icon. You see the Utility menu:

For information about these utilities, see [Maintenance and Transportation](#)

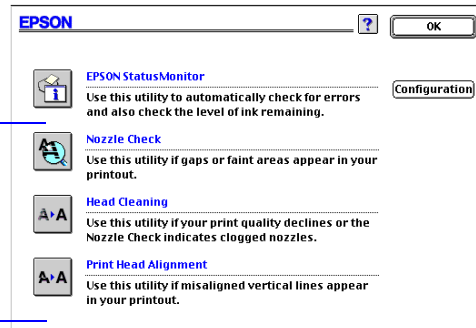

- 3 Click the **EPSON StatusMonitor** icon. The software checks the amount of ink remaining in the printer and displays the Status Monitor window:

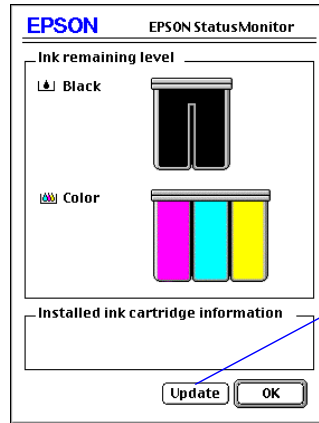

Click to recheck the ink level

- 4 To recheck the ink level check, click the **Update** button. To close the Status Monitor dialog box, click **OK**.

Selecting Configuration Options

You can configure the way you want the printer to handle error and warning messages, ink level checks, and temporary spool folders in the Configuration Settings dialog box. Follow these steps:

- 1 Choose **Page Setup** or **Print** from the File menu in your application. You see a printer settings dialog box.
- 2 Click the  Utility icon. You see the Utility menu.
- 3 Click the **Configuration** button. You see the Configuration Settings dialog box:

Printing stops when these messages appear

Printing continues when these messages appear

Spooled print job files are stored in these folders

Click here to check for errors and/or the ink level before printing

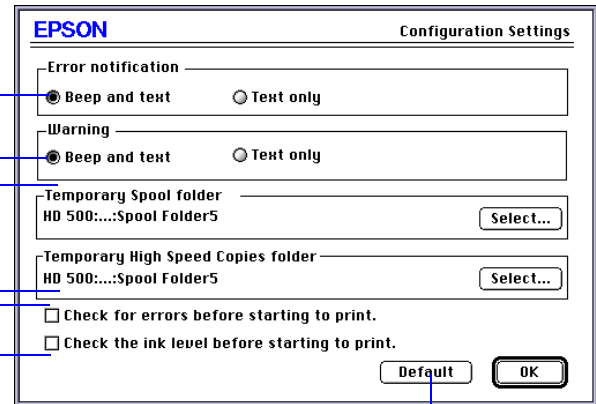

Click here to select the default settings



- 4 Select the configuration options you want as follows:
 - ▶ **Error notification** lets you select whether you want your system to beep and display error message text or just display text if your printer encounters an error.
 - ▶ **Warning** lets you choose whether warning messages beep and display text or display text only.
 - ▶ **Temporary Spool folder** and **Temporary High Speed Copies folder** let you select the folders on your hard disk that store the temporary print job and high speed multiple-copy print job files created when you send a job to the printer. Click the **Select** button to change the folder from the default folder shown.
 - ▶ Click the **Check for errors before starting to print** checkbox if you want your software to check for errors before starting your print job.
 - ▶ Click the **Check the ink level before starting to print** checkbox if you want your software to check for a low ink condition before starting your print job.
- 5 When you're finishing changing your configuration options, click **OK** to return to the Utility menu.

Maintenance and Transportation

It's easy to keep your EPSON Stylus COLOR 740i printer working at its best. Just follow the simple instructions in this chapter for:

- ▶ [Replacing an Ink Cartridge](#)
- ▶ [Cleaning the Print Head](#)
- ▶ [Aligning the Print Head](#)
- ▶ [Cleaning the Printer](#)
- ▶ [Transporting the Printer](#)

Replacing an Ink Cartridge

When the  black or  color ink out light flashes, the indicated cartridge is low on ink. This is a good time to make sure you have a new cartridge. When the light stays on, the cartridge is empty and you need to replace it.



Caution:

To ensure good results, use genuine EPSON cartridges and do not refill them. Other products may cause damage to your printer not covered by EPSON's warranty.

Use these EPSON ink cartridges within six months of installing them and before the expiration date on the package:



Black ink cartridge S020189

Color ink cartridge S020191

When you need new ink cartridges, contact your dealer or call EPSON Accessories at (800) 873-7766 or visit our web site at www.epsonsupplies.com (U.S. sales only). In Canada, please call (800) 873-7766 for dealer referral.

If you need to replace an ink cartridge **before** the lights flash (because the ink is too old, for example) follow the instructions in [Replacing an Outdated Ink Cartridge](#).

Removing and Installing Ink Cartridges

You can replace a cartridge when the  black or  color ink out light is either flashing or on. (If you press the  cleaning button when **both** ink out lights are **off**, the printer cleans the print heads, as described in [Cleaning the Print Head](#).)

Follow these steps to replace ink cartridges:

- 1 Remove the new ink cartridge from its packaging.
- 2 Remove **only** the yellow part of the tape seal on top as shown below. **Don't pull off the blue portion or try to remove the clear seal underneath the cartridge.**



Caution:

You must remove the yellow tape from the top of the cartridge or you will permanently damage it. Do not remove the clear seal from the bottom of the cartridge; ink will leak out.

To avoid damaging the printer, never move the print head by hand.

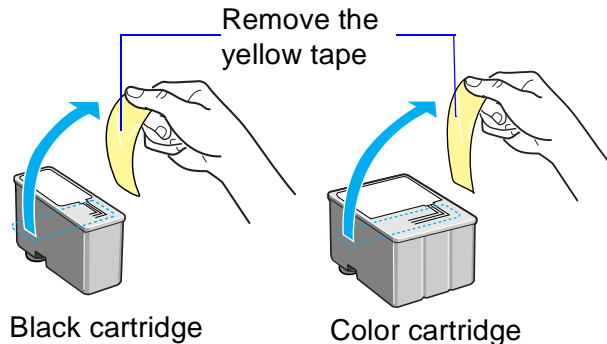

- 3 Make sure the printer is turned on and not printing, then open the printer cover.





Caution:

Don't open the clamp or remove a cartridge except to replace it with a new one. Once you remove a cartridge, you can't reuse it, even if it contains ink.



Warning:

If ink gets on your hands, wash them thoroughly with soap and water. If ink gets into your eyes, flush them immediately with water.

- 4 Press the  cleaning button and hold it for about three seconds until the print head moves left and the  power light begins flashing.

(The print head returns to its home position if you don't proceed to step 5 within 60 seconds.)

- 5 Pull up the ink cartridge clamp. The cartridge rises up from its holder.

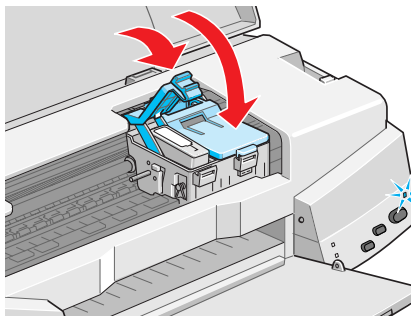

- 6 Lift the cartridge out of the printer and dispose of it carefully.

- 7 Lower the new ink cartridge into its holder with the label facing up and toward the back of the printer.

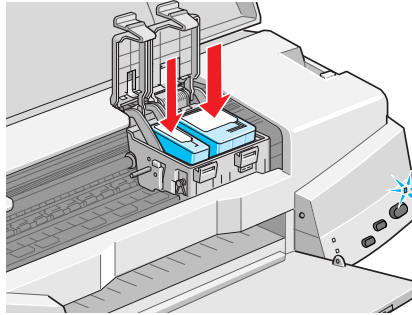

Caution:

Never turn off the printer while the power light is flashing, unless the printer hasn't moved or made any noise for more than 5 minutes.



- 8 Press down the ink cartridge clamp until it locks in place.
- 9 If you need to replace the other ink cartridge, repeat the preceding steps before going on to step 10.
- 10 Press the  cleaning button and close the printer cover.

The printer moves the print head and begins charging the ink delivery system. (Even if you don't press the button, ink charging begins 60 seconds after you close the clamp.)

The power light flashes, and the printer makes various sounds. Charging takes a couple minutes. When it's finished, the power light stops flashing and stays on.

Replacing an Outdated Ink Cartridge

If an ink cartridge is more than six months old, you may need to replace it. How can you tell? You may notice that your printouts don't look as good as they used to. If print quality doesn't improve after cleaning and aligning the print head, you can replace one or both cartridges.



Follow these steps to replace an ink cartridge **before** the  black or  color ink out light is flashing or on:





Caution:

To avoid damaging the printer, never move the print head by hand.

Never turn off the printer while the  power light is flashing, unless the printer hasn't moved or made any noise for more than 5 minutes.

- 1 Prepare your new ink cartridge for installation as described in [Removing and Installing Ink Cartridges](#).
- 2 Make sure the printer is turned on and not printing, then open the printer cover.
- 3 Press the  load/eject button and hold it down for three seconds until the print head moves to the left. The  power light begins flashing.
- 4 Remove the old ink cartridge and install the new cartridge as described in [Removing and Installing Ink Cartridges](#). Don't press any control panel buttons, however.
- 5 Press the  load/eject button and close the printer cover.

The printer moves the print head and begins charging the ink delivery system. The  power light flashes and the printer makes various sounds. Charging takes a couple minutes. When it's finished, the  power light stops flashing and stays on.

Cleaning the Print Head



If your printed image is unexpectedly light or faint, or dots are missing from the image, you may need to clean the print head. This unclogs the nozzles so they can deliver ink properly.

Cleaning the print head uses ink, so clean it only if print quality declines. You can clean the print head in either of the following ways:

- ▶ With the Head Cleaning utility in your printer software (when connected to a local port, not over a network)
- ▶ Using the printer's control panel buttons

Using the Head Cleaning Utility

Follow these steps to run the Head Cleaning utility:

- 1 Make sure the printer is turned on but not printing, and the  black and  color ink out lights are off.
- 2 Start an application and open a document.
- 3 Access the printer settings dialog box as described in [Printing from Windows](#) or [Printing from a Macintosh](#).
- 4 Click the **Utility** tab (Windows) or the  Utility icon (Macintosh). You see the Utility menu.
- 5 Click the **Head Cleaning** icon.



Caution:
Never turn off the printer while the power light is flashing, unless the printer hasn't moved or made any noise for more than 5 minutes.

- 6 Follow the instructions on the screen to clean the print head. Cleaning takes a couple minutes, during which the printer makes some noise and the power light flashes.
When the power light stops flashing, run a nozzle check to test the results and reset the cleaning cycle.
- 7 Make sure paper is loaded in the printer and click **Print nozzle check pattern** (Windows) or **Confirmation** (Macintosh). Then click **Next**. The nozzle check pattern prints on your printer; see [Examining the Nozzle Check Pattern](#) for details.
- 8 If the nozzle check pattern is complete, click **Finish**.
If the pattern is missing dots, click **Clean** to run another cleaning cycle. If you don't see any improvement after cleaning two or three times, check the print quality solutions in [Improving Print Quality](#).

Using the Control Panel

Follow these steps to clean the print head:

- 1 Make sure the printer is turned on and not printing, and that the black and color ink out lights are off.
- 2 Press the cleaning button and hold it down for three seconds. Cleaning takes a couple minutes, during which the printer makes some noise and the power light flashes.



Caution:
Never turn off the printer while the power light is flashing, unless the printer hasn't moved or made any noise for more than 5 minutes.

- 3** After the power light stops flashing, print a page to test the print quality and reset the cleaning cycle.
If you're connected directly to the printer, run a nozzle check. Go to step 4.
If you're using DOS or printing over a network, open an application and print a document containing black and color data. Then go to step 8.
- 4** Start an application, open a document, and access the printer settings dialog box as described in [Printing from Windows](#) or [Printing from a Macintosh](#).
- 5** Click the **Utility** tab (Windows) or the  Utility icon (Macintosh). You see the Utility menu.
- 6** Make sure paper is loaded in the printer and click the **Nozzle Check** icon, then click **Next**. The nozzle check pattern prints on your printer; see [Examining the Nozzle Check Pattern](#) for details.
- 7** If the nozzle check pattern is complete, click **Finish**.
If the pattern is missing dots, click **Clean** to run another cleaning cycle.
- 8** If you don't see any improvement after cleaning two or three times, check the print quality solutions in [Troubleshooting](#).

Examining the Nozzle Check Pattern

Examine the nozzle check pattern you print. It should look something like this, with the lower pattern colored magenta, cyan, and yellow:

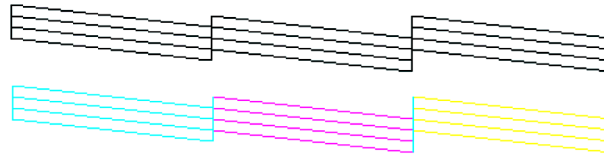

Each staggered horizontal and straight vertical line should be complete, with no gaps in the dot pattern. If your printout looks okay, you're done. If any dots are missing, as shown below, clean the print head again; see [Cleaning the Print Head](#) for instructions.

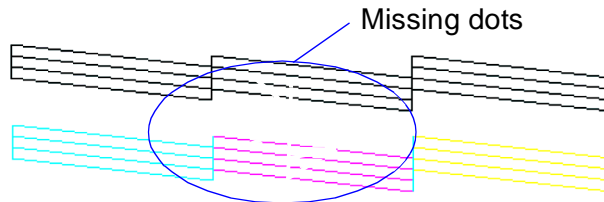



Caution:

Load paper that's at least 8.27 inches (210 mm) wide. This prevents ink from spraying inside the printer and smudging your printouts.

For the best results, load EPSON ink jet paper in the printer whenever you check the print head alignment.

Aligning the Print Head

If your printouts contain misaligned vertical lines, you may need to align the print head using the Print Head Alignment utility in your printer software. Your printer must be connected to a local port, not on a network, to use this utility. Follow these steps:

- 1 Make sure the printer is turned on and paper is loaded.
- 2 Start an application and open a document.
- 3 Access the printer settings dialog box as described in [Printing from Windows](#) or [Printing from a Macintosh](#).
- 4 Click the **Utility** tab (Windows) or the  Utility icon (Macintosh). You see the Utility menu.
- 5 Click the **Print Head Alignment** icon.
- 6 Follow the instructions on the screen to print a test page and select the correct alignment.



Caution:
Don't touch the gears
inside the printer.

Never use alcohol or
thinner for cleaning;
they can damage the
printer components
and case.

Don't use a hard or
abrasive brush.

Don't get water on the
printer components.

Don't spray lubricants
or oils inside the
printer.

Cleaning the Printer

To keep your printer working at its best, you should clean it several times a year, following these steps:

- 1 Turn off the printer, unplug the power cord, and disconnect the printer cable.
- 2 Remove all the paper from the sheet feeder.
- 3 Clean the exterior of the printer with a soft, damp cloth.
- 4 Clean ink out of the printer's interior with a soft, damp cloth.

Transporting the Printer

If you move your printer some distance, you need to prepare it for transportation in its original box. Follow these steps:



Caution:
To avoid damage,
always leave the ink
cartridges installed
when transporting
the printer.

- 1 Turn on the printer and wait until the print head locks in the far right position. Then turn off the printer.
- 2 Unplug the power cord from the electrical outlet. Then disconnect the interface cable from the printer.
- 3 Remove any paper from the printer and remove the paper support.
- 4 Push in the output tray extensions and close the tray.
- 5 Repack the printer and attachments in the original box using the protective materials that came with it. See the *Unpacking Sheet* that was packed with your printer.

Be sure to keep the printer level as you transport it. If you notice a decline in print quality after transporting the printer, clean the print head (see [Cleaning the Print Head](#)); if output is misaligned, align the print head (see [Aligning the Print Head](#)).

Troubleshooting

As you use your printer, you may occasionally experience a paper jam or other problem. The first thing you should do is diagnose the problem, following the guidelines in this chapter. Then try the most likely solutions until the problem is fixed.

This chapter covers the following problems and solutions:

- ▶ [Diagnosing Problems](#)
- ▶ [Improving Print Quality](#)
- ▶ [Solving Printing Problems](#)
- ▶ [Solving Printer Software Problems](#)
- ▶ [Fixing Paper Problems](#)
- ▶ [Solving Miscellaneous Printout Problems](#)
- ▶ [Uninstalling Printer Software](#)
- ▶ [Where To Get Help](#)

Diagnosing Problems

There are a number of ways to diagnose printer problems:

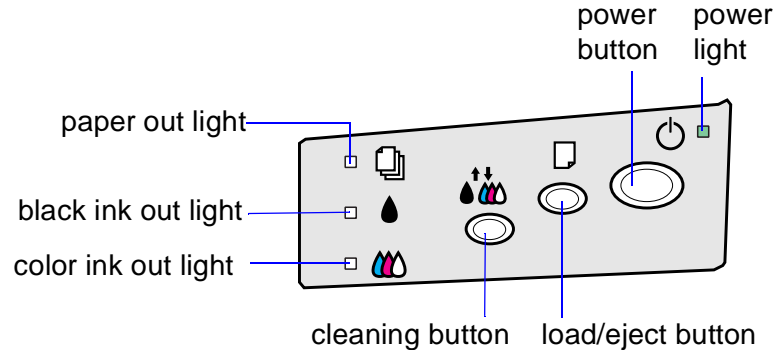

- ▶ To identify the most common problems, check the printer's lights; see [Checking the Control Panel Lights](#) for details.
- ▶ You can also view the Printer Status window to identify common problems, if you installed Status Monitor 2 with Windows 95, 98, or NT 4.0. For instructions, see [Using the Printer Status Window](#). On a Macintosh, you can check your ink levels using the Status Monitor; see [Using the Macintosh Status Monitor](#) for details.
- ▶ To determine whether the problem is caused by the printer itself, run a printer operation check. See [Running a Printer Operation Check](#) for instructions.
- ▶ If you see an error message about your printer settings or have problems with color quality, you may need to confirm your Printer ID number. See [Confirming the Printer ID Number](#) for details.
- ▶ For the latest information, check the Help programs and the ReadMe files in the EPSON program group or folder.
- ▶ If any of the suggested solutions in this chapter tell you to uninstall and then reinstall your printer software, see [Uninstalling Printer Software](#) for instructions.
- ▶ If none of the suggested solutions here solve your problem, contact your EPSON dealer or see [Where To Get Help](#).

Checking the Control Panel Lights





Follow these guidelines when the control panel lights come on or flash:



When the  paper out light *flashes*, paper is jammed in the printer. Turn off the printer, remove all the paper (including any pieces torn off inside), then reload the stack. Turn on the printer and press the  load/eject button. For tips on avoiding paper jams, see [Paper jams inside the printer](#).



When the  paper out light *comes on*, your paper ran out or is incorrectly loaded. Load paper in the feeder and then press the  load/eject button.



When an ink out light *flashes*, your ink supply is low. Make sure you have a replacement cartridge.

- or ●● When an ink out light *comes on*, you need to replace the ink cartridge. See [Replacing an Ink Cartridge](#) for instructions.
- ⏻ ●● ●● When the ⏻ power and ●● paper out lights *flash* and the ● black and ●● color ink out lights *come on*, jammed paper may be blocking movement of the print head. See [The ⏻ power and ●● paper out lights are flashing and the ● black and ●● color ink out lights are on](#) for more information.
- ⏻ ●● ●● When all the lights *flash*, your printer may have an internal error. See [All the lights are flashing](#) for more information.





Running a Printer Operation Check

You can run a printer operation check to determine whether the problem comes from the printer itself or some other source.

- ▶ If the results are satisfactory, the problem lies in your software settings, the interface cable, or your computer.
 - ▶ If the check page does not print correctly, you have a problem with your printer. See the suggestions in this chapter for possible solutions.
- 1 Make sure both the printer and computer are turned off.
 - 2 Disconnect the interface cable from the printer.



Caution:
Load paper that's at least 8.27 inches (210 mm) wide. This prevents ink from spraying inside the printer and smudging your printouts.

- 3 Make sure paper is loaded in the printer.
- 4 Hold down the  load/eject button and press the  power button. Hold down the  load/eject button until the  power light starts to flash, then release it.

The printer prints its ROM version number and a nozzle check pattern (shown in [Examining the Nozzle Check Pattern](#)).

- 5 To end the check, turn off the printer. Then reconnect the interface cable and turn on your printer and computer.

Confirming the Printer ID Number

If you're using Windows 95, Windows 98, or Windows NT, you can use the Printer and Option Information utility to confirm the Printer ID. Color quality may improve after you confirm the ID number.

If you're using Status Monitor 2, this information is updated automatically. However, if a message appears prompting you to enter settings or if you change the printer's configuration, you'll need to update the Printer ID manually. Follow these steps:



- 1 Make sure letter-size paper is loaded in your printer.
- 2 Access the main printer settings dialog box as described in [Printing from Windows](#).
- 3 Click the **Utility** tab. Then click the **Printer and Option Information** icon.

- 4 Click the **Settings Sheet** button. The printer prints the Printer ID on a sheet of paper.
- 5 Make sure the Printer ID shown in the Printer and Option Information dialog box matches the ID on the Settings Sheet. If they don't match, change the ID numbers in the dialog box to match those on the Settings Sheet.
- 6 Click **OK** to exit and save your settings.

Improving Print Quality

If you find that your print quality has declined, you can often improve it by doing one of the following:

- ▶ Clean the print head following the instructions in [Cleaning the Print Head](#).
- ▶ Use higher quality paper appropriate for your print job. See [Selecting Special Media](#) for a list of EPSON papers.
- ▶ Match the **Media Type** in the printer software to the type of paper you loaded in the printer. Then the printer software can automatically select other settings for the best quality. (See [Basic Printing](#) and [Selecting Special Media](#) for details.)
- ▶ Turn off **High Speed** mode in the Advanced dialog box, as described in [Customizing Print Quality and Special Effects](#).

- ▶ Make sure **Economy** mode is turned off in the printer software, as described in [Customizing Print Quality and Special Effects](#).
- ▶ Check the status of the  black and  color ink out lights, then replace the ink cartridges, if necessary, as described in [Replacing an Ink Cartridge](#).

Here are some detailed solutions to print quality problems.

The printed image has horizontal banding



Possible cause	Solution
The Media Type setting doesn't match the loaded paper.	Make sure the Media Type setting matches the paper you're using. See Printing from Windows or Printing from a Macintosh for instructions.
The printable side of the paper is face down.	Remove the paper and reload it with the printable side face up. See Media Loading and Handling Guidelines for instructions.
The print head nozzles are clogged.	Clean the print head. See Cleaning the Print Head for instructions.
The ink cartridges are low on ink.	Check the  black and  color ink out lights to see which cartridge you may need to replace. See Replacing an Ink Cartridge for instructions.
The MicroWeave option is not turned on.	Turn on MicroWeave (if available) in the Advanced dialog box. See Customizing Print Quality and Special Effects for more information.
The Maximum Printable Area setting is turned on.	Select the Standard Printable Area setting to avoid banding in the expanded margin area. See Selecting Paper Size and Orientation Options for more information.

Vertical lines are misaligned or vertical banding appears



Possible cause	Solution
The print head nozzles are clogged.	Clean the print head. See Cleaning the Print Head for instructions.
The paper thickness lever is in the + position.	Set the paper thickness lever to the 0 position and try printing again. See Envelopes for instructions.
The High Speed setting is turned on.	Turn off the High Speed setting if vertical lines are misaligned. See Customizing Print Quality and Special Effects for information.
The print head is misaligned.	Run the Print Head Alignment utility. See Aligning the Print Head for instructions.

The printed image has incorrect or missing colors

Possible cause	Solution
The Ink option is set to Black .	Change the Ink setting to Color . See Printing from Windows or Printing from a Macintosh for instructions.
The Media Type setting doesn't match the loaded paper.	Make sure the Media Type setting matches the paper you're using. See Printing from Windows or Printing from a Macintosh for instructions.
The Halftoning and Color Management options are set incorrectly for your document type.	Use the correct settings for the project you're printing, following the instructions in Customizing Print Quality and Special Effects and Customizing Color Settings .

Possible cause	Solution
The printable side of the paper is face down.	Remove the paper and reload it with the printable side face up. See Media Loading and Handling Guidelines for instructions.
The ICM (Windows 95 or Windows 98), sRGB (Windows 95, 98, NT), or ColorSync (Macintosh) settings are incorrect for your document.	Use the Automatic mode setting or choose a different Rendering Intent setting (Macintosh). See Advanced Printing for more information.
The print head nozzles are clogged.	Clean the print head. See Cleaning the Print Head for instructions.
The ink cartridges are low on ink or one or more ink colors are empty.	Check the  black and  color ink out lights to see which cartridge you may need to replace. See Replacing an Ink Cartridge for instructions.
The colors displayed on your monitor don't match the printed colors.	Because your monitor and printer use different technologies to represent colors, your printed colors can't exactly match the colors you see on your monitor screen. Use the ICM (Windows 95 or Windows 98), sRGB (recommended for Windows 98 only), or ColorSync (Macintosh) settings to get as close a match as possible. See Advanced Printing for more information.
The color settings in your application software need adjustment.	You may be able to adjust various color settings in your application software. See your software documentation for more information.

The printed image is faint or has gaps

Possible cause	Solution
The print head nozzles are clogged.	Clean the print head. See Cleaning the Print Head for instructions.
The Media Type setting doesn't match the loaded paper.	Make sure the Media Type setting matches the paper you're using. See Printing from Windows or Printing from a Macintosh for instructions.
The loaded paper is damaged, old, or dirty.	Remove the paper and reload a new stack with the printable side face up. See Media Loading and Handling Guidelines for instructions.
The ink cartridges are low on ink.	Check the  black and  color ink out lights to see which cartridge you may need to replace. See Replacing an Ink Cartridge for instructions.

The printed image is blurry or smeared

Possible cause	Solution
The loaded paper is damaged, old, or dirty.	Remove the paper and reload a new stack with the printable side face up. See Media Loading and Handling Guidelines for instructions.
The paper thickness lever is in the wrong position.	Set the paper thickness lever to the + position to print on envelopes or other thick media; set the lever to the 0 position to print on other media types. See Envelopes for instructions, then try printing again.
The paper is damp or the printable side is face down.	Remove the paper and reload a new stack with the printable side face up. See Media Loading and Handling Guidelines for instructions.
You loaded special media without a support sheet.	Follow the special media loading instructions in Media Loading and Handling Guidelines and on the paper packaging for media that require support sheets. Also try loading your media one sheet at a time.

Possible cause	Solution
You tried to print on cardboard or other non-recommended media.	Make sure your paper or media meets the specifications listed in Paper . If your printouts are still blurry after you change paper, clean the print head as described in Cleaning the Print Head .
The Media Type setting doesn't match the loaded paper.	Make sure the Media Type setting matches the paper you're using. See Printing from Windows or Printing from a Macintosh for instructions.
Ink has leaked inside the printer.	Clean carefully inside the printer to remove spilled ink. See Cleaning the Printer for instructions.
You're using the High Speed and MicroWeave settings with a misaligned print head.	Turn off High Speed following the instructions in Customizing Print Quality and Special Effects . Then run the Print Head Alignment utility following the instructions in Aligning the Print Head .
The resolution of your image may be too low.	If a photographic image looks grainy or rough, try using the PhotoEnhance3 (PhotoEnhance on Windows 3.1) and Sharpness setting to improve the printed quality. See Customizing Color Settings for details. You can also increase the image resolution using your image-editing software, or decrease the size of the image.

Solving Printing Problems

If the printer won't print, first check that:

- ▶ The printer is turned on and the ⏻ power light is on, but not flashing.
- ▶ Paper is loaded in the printer.
- ▶ The printer is plugged into a working electrical outlet that's not controlled by a switch or timer.
- ▶ The interface cable is securely connected to the printer and computer.

If you still can't print, check the following solutions.



All lights are off

Possible cause	Solution
The printer is not receiving power.	Try these solutions: <ul style="list-style-type: none">▶ Make sure the printer is turned on.▶ Turn off the power and plug in the power cord securely.▶ Make sure the outlet is not controlled by a switch or timer and is operable.

Only the power light is on, but nothing prints

Possible cause	Solution
The interface cable is not connected securely.	Turn off your printer and computer. Then make sure the cable is connected securely and meets the printer's specifications.
The printer has an internal problem.	Turn off the printer and computer, disconnect the interface cable, and run a printer check as described in Running a Printer Operation Check .
The printer or application software is installed incorrectly.	If the printer check works, make sure your printer and application software are correctly installed. If you're printing on a network, you may need to set up your printer for network printing.
Your computer doesn't have enough memory to handle the file you're printing.	Try one of the following: <ul style="list-style-type: none">▶ Reduce the resolution of your image.▶ Select fewer colors or a lower resolution for your display or monitor.▶ Add more memory to your computer.
Printing is stalled.	<p>In Windows, delete the stalled print jobs in Spool Manager; see Using the Spool Manager for instructions. In Windows NT, uninstall the EPSON Printer Port. Click Start, point to Programs, EPSON Printers, and select EPSON Printer Port Uninstall.</p> <p>On a Macintosh, delete stalled print jobs using Monitor3 (see Using Monitor3) or open the Extensions folder, EPSON folder, and Spool folder, and then delete any queued files.</p>
The print head nozzles are clogged or the ink cartridges are too old.	Clean the print head; see Cleaning the Print Head for instructions. If cleaning doesn't help, replace the cartridges. For information on cartridge life and replacement instructions, see Replacing an Ink Cartridge .

The paper out light is flashing or on

Possible cause	Solution
If flashing, paper is jammed.	Remove the paper and follow the guidelines for preventing jams as described in Paper jams inside the printer .
If on, paper is used up or is loaded incorrectly.	Load paper or remove the stack and reload it as described in the <i>Start Here</i> card and in Media Loading and Handling Guidelines . Then press the  load/eject button to turn off the  paper out light and resume printing.

A black or color ink out light is flashing or on

Possible cause	Solution
If flashing, the ink supply is getting low.	You need to replace the indicated ink cartridge soon; see Replacing an Ink Cartridge for instructions.
If on, the ink cartridge is empty.	You must replace the indicated ink cartridge now to be able to print; see Replacing an Ink Cartridge for instructions.

The power and paper out lights are flashing and the black and color ink out lights are on

Possible cause	Solution
Jammed paper may be blocking movement of the print head.	Turn off the printer, wait a few seconds, and turn it back on to eject any paper. If no paper is ejected, turn off the printer, remove the jammed paper, and turn it on again. If the lights are still flashing and on, contact your EPSON dealer or see Where To Get Help .

All the lights are flashing

Possible cause	Solution
You haven't removed all the packing material from the printer.	Remove the tape and other packing material following the instructions on the unpacking sheet.
An internal error may have occurred.	Turn off your printer, wait a few seconds, and turn it on again. If the lights still flash or stay on, contact your EPSON dealer or see Where To Get Help .

The printer has finished charging the ink cartridge, but the power light is still flashing

Possible cause	Solution
The ink cartridge clamp isn't locked down.	Press down the clamp to lock it.
Packing material remains in the printer.	Remove the tape and other packing material following the instructions on the unpacking sheet.
The printer needs to initialize.	If the printer is not moving or making noise, but the  power light is still flashing after more than 5 minutes, turn the printer off. If the light is still flashing when you turn it back on, contact your EPSON dealer or see Where To Get Help .

Solving Printer Software Problems

If you have trouble with your printer software, first check that your printer is selected as the default Windows printer or as the current printer in the Macintosh Chooser.

If you still have problems with your printer software, check the following solutions.

The printer software installed with Windows 3.1 doesn't work correctly after you upgrade to Windows 95 or Windows 98

Possible cause	Solution
Your printer software is not set up correctly for the new operating system.	Uninstall the printer software after installing Windows 95 or Windows 98, as described in Uninstalling Printer Software . Then reinstall it as described in the <i>Start Here</i> card.

When installing your printer software, you see the Windows New Hardware Found window

Possible cause	Solution
Windows has detected your printer.	If your printer is connected using a parallel connection, click Cancel . <i>Never select any other option on the New Hardware Found window.</i>
	If your printer is connected using a USB port, see the <i>Printer Basics</i> book for instructions on using Windows 98 plug-and-play.

You see a spooling error message (Windows)

Possible cause	Solution
If you see error messages or printing is very slow, the problem may be caused by temporary files (Windows 3.1 only).	Change the Spool Manager default directory (Windows 3.1 only), following the instructions in Using the Spool Manager .
Your hard drive is too full.	Delete unnecessary files to make room on the drive.
Your computer doesn't have enough memory for the file you're printing.	Try one of the following: <ul style="list-style-type: none">▶ Reduce the resolution of your image.▶ Select fewer colors or a lower resolution for your display or monitor.▶ Add more memory to your computer.

You see a memory error message (Macintosh)

Possible cause	Solution
You need to increase the memory allocation for your application, EPSON Monitor3, or both.	Choose Get Info from the File menu when the application is active or EPSON Monitor3 is selected and increase the memory requirements. See Using Monitor3 for more information. If that doesn't work, turn off background printing in the Chooser or in your printer software; see Setting Up Background Printing Options for instructions. You won't be able to use Monitor3.

In Windows 95, Windows 98, or Windows NT, the Status Monitor 2 window doesn't appear

Possible cause	Solution
You didn't restart your computer after installing Status Monitor 2.	Click Start , select Shut Down , click Restart the computer , and click Yes to restart your computer. Then try using Status Monitor 2.
Bi-directional support is not enabled.	Click Start , select Settings , and click Printers . Right-click the EPSON Stylus COLOR 740 icon and select Properties . Click the Details tab, then click the Spool Settings button. Click the Enable bi-directional support for this printer radio button to turn on bi-directional support. Click OK twice, then close the Printers window and try printing again.
You're using ScanDisk.	Before using ScanDisk, turn off background monitoring in Status Monitor 2. (See Enabling Background Monitoring for instructions.) Then turn it back on when you're finished using ScanDisk.

Printing is too slow

Possible cause	Solution
Your printer software options are set incorrectly.	For the fastest printing, try the following printer software settings: <ul style="list-style-type: none">▶ Set Print Quality to Economy.▶ Turn MicroWeave off.▶ Turn High Speed on.▶ Choose Black ink and No Halftoning. See Advanced Printing for instructions.
Your system doesn't have enough resources.	<ul style="list-style-type: none">▶ Clear space on your hard disk or run a defragmentation utility.▶ Don't run too many applications at the same time.▶ Turn off virtual memory.▶ Increase your system's memory (RAM) and/or processor speed.
You're using background printing on a Macintosh.	Choose Get Info from the File menu when the application is active or EPSON Monitor3 is selected and increase the memory requirements. See Using Monitor3 for more information. If that doesn't work, turn off background printing in the Chooser or in your printer software; see Setting Up Background Printing Options for instructions. You won't be able to use Monitor3.
You're not using ECP or Enhanced mode and/or DMA transfers.	If your computer supports ECP or Enhanced mode and/or DMA transfers, turn them on to speed up printing. See your computer documentation for details.

Your printer switches to the modem port or won't confirm on the printer port (Macintosh)

Possible cause	Solution
Your Macintosh has extension conflicts.	Make sure AppleTalk [®] is inactive. In the Chooser, select any Apple serial printer (such as the LaserWriter) and choose the printer port. Close the Chooser, then reopen it and select the SC 740 icon and the printer port. Then restart your system.
You're using an AppleTalk cable.	Make sure you're using a standard Apple System Peripheral-8 cable. See Macintosh System Requirements for more information.

Your printer icon doesn't appear in the Chooser (Macintosh)

Possible cause	Solution
Your Macintosh has extension conflicts.	Disable Quick Draw GX in the Extensions Manager. Make sure EPSON Monitor3 and SC 740 are enabled, and then restart your Macintosh.
The Chooser contains too many items.	Delete unused items or move them to the Extensions (Disabled) folder. Then check for your printer icon in the Chooser again.

Your application program can't open your image file (Macintosh)

Possible cause	Solution
Not enough memory is allocated to the application.	Highlight the program icon and select Get Info from the File menu, then increase the memory allocated to the application.

The “SC 740 cannot be used” message appears (Macintosh)

Possible cause	Solutions
The printer software has been corrupted.	Remove and reinstall the printer software as described in Uninstalling Printer Software . Then, in the Extensions Manager, disable Quick Draw GX, enable EPSON Monitor3 and SC 740, and restart.

Your printer doesn't print correctly as a remote printer (Windows NT)

Possible cause	Solution
You may need to use a different network path and printer port.	Select a different printer port in the printer's Properties window and enter the new network path to your printer at the DOS prompt. Then restart your computer. See your Windows NT documentation for instructions on changing the printer port and network path.

Fixing Paper Problems

To avoid most paper handling problems:

- ▶ Use smooth, high-quality media designed for ink jet printers that meets the media specifications in [Paper](#).
- ▶ Follow all loading and handling instructions included with the media.
- ▶ Load the media with the printable side face up as described in the *Start Here* card and in [Media Loading and Handling Guidelines](#).

If you have any paper problems, check here for solutions.

Paper doesn't feed

Try this	Then do this
Remove the stack of paper from the printer.	<p>Check that the paper isn't:</p> <ul style="list-style-type: none">▶ Curled or creased.▶ Too old. (See Media Loading and Handling Guidelines or your paper packaging for more information.)▶ Loaded above the arrow on the left edge guide.▶ Jammed inside the printer. (If the  paper out light is flashing, paper is jammed.) <p>Then reload the paper against the right edge guide as described in the <i>Start Here</i> card and in Media Loading and Handling Guidelines, adjusting the left edge guide to fit the paper's width.</p>

Multiple pages feed at the same time

Try this	Then do this
Remove the stack of paper from the printer.	<ul style="list-style-type: none">▶ Make sure the paper isn't too thin (see the specifications in Paper).▶ Fan all the edges of the stack of paper to separate the sheets.▶ Reload the paper as described in the <i>Start Here</i> card and in Media Loading and Handling Guidelines.▶ If too many copies of a page or document are printing, check the Copies settings in both the printer software and your application program. See Selecting Paper Size and Orientation Options for more information.

Paper jams inside the printer

Try this	Then do this
Turn off your printer, open the cover, and remove all the paper that's inside, including any little pieces that may have torn off.	Load more paper in the printer, following the instructions in the <i>Start Here</i> card and in Media Loading and Handling Guidelines . If your paper jams frequently, make sure you: <ul style="list-style-type: none">▶ Use smooth, high-quality paper, loaded printable side up.▶ Fan the stack and then even the edges before loading it.▶ Load paper beneath the arrow mark on the left edge guide.▶ Adjust the left edge guide to fit the width of your paper.

Paper doesn't eject fully or is wrinkled

Possible cause	Solution
If the paper doesn't eject fully, you may have set the wrong paper size.	Press the  load/eject button to eject the paper. Then make sure you select the correct paper size in your printer software. See Selecting Paper Size and Orientation Options for instructions.
If it's wrinkled when it comes out, the paper may be damp or too thin.	See the specifications in Paper for ranges of paper thicknesses you can print with, as well as environmental requirements for storage.

Solving Miscellaneous Printout Problems

If your printout results are not what you expected, try these solutions.

Characters are incorrect or garbled

Possible cause	Solution
Your printer is not selected in your application or as the Windows default printer.	Select your printer in your application or select it as the default Windows printer. See your Windows documentation or online help for instructions.
Your printer is not selected in the Macintosh Chooser.	Select your printer in the Chooser as described in the <i>Start Here</i> card.
Printing is stalled.	<p>In Windows, delete the stalled print jobs in Spool Manager; see Using the Spool Manager for instructions. In Windows NT, uninstall the EPSON Printer Port. Click Start, point to Programs, EPSON Printers, and select EPSON Printer Port Uninstall.</p> <p>On a Macintosh, select the stalled print jobs in Monitor3 (see Using Monitor3) or open the Extensions folder, EPSON folder, and Spool folder, and delete any queued files.</p>

Possible cause	Solution
The interface cable is not securely connected.	Turn off your printer and computer. Then make sure the cable is connected securely and meets the printer's specifications.
Your video driver may be conflicting with the EPSON printer driver.	Change to a standard VGA driver (see your computer or video card documentation for instructions). If your printout is correct, your video driver is interfering with the printer driver. Contact your computer or video card manufacturer for an updated driver.

The image is inverted as if viewed in a mirror

Possible cause	Solution
You used a Flip Horizontal option.	Turn off the Flip Horizontal or mirror setting in your application software or the printer software. See Customizing Print Quality and Special Effects for instructions.

The image size or position is incorrect

Possible cause	Solution
The paper and/or layout options are set incorrectly.	Check the paper settings and the settings on the Layout dialog box (Windows 95, 98, and NT, or Macintosh only). See Selecting Print Layout Options for instructions. Also check the paper and layout options in your application software.

The margins are incorrect

Possible cause	Solution
Margins are set incorrectly in your application software.	Check your software documentation for instructions on selecting the correct margins for your paper size and within its printable area. See Printable area for more information.
Paper settings in the printer software are incorrect for your paper size.	Check the paper size, orientation, printable area, and layout settings to make sure they're correct for your paper size. See Selecting Paper Size and Orientation Options and Selecting Print Layout Options for more information.

A portion of your image doesn't print (Macintosh)

Possible cause	Solution
Your system doesn't have enough available memory.	Close any other applications you are running and turn off background printing as described in Setting Up Background Printing Options .
You need to increase the memory allocation for your application, EPSON Monitor3, or both.	Choose Get Info from the File menu when the application is active or EPSON Monitor3 is selected and increase the memory requirements. See Using Monitor3 for more information. If that doesn't work, turn off background printing in the Chooser or in your printer software; see Setting Up Background Printing Options for instructions. You won't be able to use Monitor3.

The printer prints blank pages

Possible cause	Solution
Your printer is not selected in your application or as the Windows default printer.	Select your printer in your application or select it as the default Windows printer. See your Windows documentation or online help for instructions.
Your printer is not selected in the Macintosh Chooser.	Select your printer in the Chooser as described in the <i>Start Here</i> card.
Paper settings in the printer software are incorrect for your paper size.	Check the paper size, orientation, printable area, and layout settings to make sure they're correct for your paper size. See Selecting Paper Size and Orientation Options and Selecting Print Layout Options for more information.
The print head nozzles are clogged.	Clean the print head following the instructions in Cleaning the Print Head .

Uninstalling Printer Software

If you need to uninstall and reinstall your printer software, follow the steps in the section for your operating system:



Caution:

If you uninstall and then reinstall the printer software in Windows 95, 98, or NT 4.0, you must also uninstall and then reinstall Status Monitor 2 so it can recognize your printer.

- ▶ [Windows 95, Windows 98, and Windows NT 4.0 Instructions](#)
- ▶ [Windows 3.1 Instructions](#)
- ▶ [Macintosh Instructions](#)

Windows 95, Windows 98, and Windows NT 4.0 Instructions

- 1 Double-click the **My Computer** icon, then double-click the **Control Panel** icon.
- 2 Double-click **Add/Remove Programs**.
- 3 To uninstall the printer software, select **EPSON Printer Software** in the program list.
- 4 Click the **Add/Remove** button. Follow the instructions on the screen to uninstall your software.
- 5 Before you uninstall Status Monitor 2, turn off background monitoring as described in [Enabling Background Monitoring](#). Then follow steps 3 and 4 again. In step 3, select **EPSON Status Monitor 2** in the program list to uninstall it.

- 6 If you're using Windows 98 with a USB connection, you need to uninstall the EPSON USB Printer Device software also. Follow steps 3 and 4 again. In step 3, select **EPSON USB Printer Devices** in the list.
- 7 Restart your computer. To reinstall your software, see the *Printer Basics* book.

Windows 3.1 Instructions

- 1 Double-click the **Main** program group icon, then double-click the **Control Panel** icon.
- 2 Double-click **Printers**.
- 3 Select **EPSON Stylus COLOR 740** in the Installed Printers list and click the **Remove** button.
- 4 To reinstall your software, see the *Printer Basics* book.

Macintosh Instructions

- 1 Insert the EPSON printer software CD-ROM in your drive.
- 2 Double-click the **EPSON** icon. After a moment, you see the EPSON Stylus COLOR 740i Installer Main Menu.
- 3 Click **Re-install Printer Driver**, then click the same button on the next screen.
- 4 At the driver installation title screen, click **Continue**.

- 5 Click the arrow in the list at the top showing Easy Install, and select **Remove** from the list.
- 6 Click the **Remove** button on the bottom of the screen.
- 7 Follow the instructions on the screen to uninstall the printer software. Then restart your Macintosh.
- 8 To reinstall your software, see the *Start Here* card.

Where To Get Help

EPSON provides technical assistance through electronic support services and automated telephone services 24 hours a day. The following tables list the contact information:

Electronic support services

Service	Access
World Wide Web	From the Internet, you can reach EPSON's Home Page at http://www.epson.com .
EPSON Internet FTP Site	If you have Internet FTP capability, use your Web browser (or other software for FTP downloading) to log onto ftp.epson.com with the user name anonymous and your e-mail address as the password.
EPSON Forum on CompuServe®	Members of CompuServe can type GO EPSON at the menu prompt to reach the Epson America Forum. For a free introductory CompuServe membership, call (800) 848-8199 and ask for representative #529.

Automated telephone services

Service	Access
EPSON SoundAdvice SM	For pre-recorded answers to commonly asked questions about EPSON products 24 hours a day, seven days a week, call (800) 922-8911 .
EPSON FaxAdvice TM	Access EPSON's technical information library by calling (800) 922-8911 . You must provide a return fax number to use this service.
EPSON Referral Service	For the location of your nearest Authorized EPSON Reseller or Customer Care Center, call (800) 922-8911 .



Note:

If you need help using another manufacturer's software with an EPSON product, see the documentation for that software for technical support information.

To speak to a technical support representative, dial (310) 974-1188 (U.S.) or (905) 709-2567 (Canada), 6 AM to 8 PM, Pacific Time, Monday through Friday and 7 AM to 4 PM, Saturday. Toll or long distance charges may apply.

Before you call, please have the following information ready:

- ▶ Product name (EPSON Stylus COLOR 740i)
- ▶ Product serial number (located on the back of the printer)
- ▶ Computer configuration
- ▶ Description of the problem

You can purchase ink cartridges, paper, manuals, and accessories from EPSON Accessories at (800) 873-7766 or visit our web site at www.epsonsupplies.com (U.S. sales only). In Canada, please call (800) 873-7766 for dealer referral.

Specifications

Printing

Printing method	On-demand ink jet
Nozzle configuration	144 black nozzles 144 color nozzles (48 cyan, 48 magenta, 48 yellow)
Resolution	Maximum 1440 × 720 dpi
Input buffer	64KB
Print direction	Bidirectional with logic seeking
Control code	ESC/P 2™ and raster graphics code and EPSON Remote
Character tables	1 italic and 10 graphics character tables
Character sets	14 international character sets and 1 legal character set
Bitmap fonts	▶ EPSON Roman (proportional) ▶ EPSON Sans Serif (proportional) ▶ EPSON Courier ▶ EPSON Prestige ▶ EPSON Script

All bitmap fonts are available in 10, 12, and 15 cpi. You can select other font/pitch combinations using ESC/P 2 commands.

Scalable fonts

- ▶ EPSON Roman
- ▶ EPSON Sans Serif
- ▶ EPSON Roman T
- ▶ EPSON Sans Serif H

All scalable fonts are available in sizes from 8 to 32 points, in 2 point increments, and four styles: normal, bold, italic, and bold italic.

The printer always uses the fonts you select with your software application. You need to use the printer's internal fonts only if your application doesn't allow you to select fonts.

Paper

Paper type	Size	Paper types	Thickness	Weight
Single sheets	Letter (8.5 × 11 inches) A4 (210 × 297 mm) A5 (148 × 210 mm) B5 (182 × 257 mm) Legal (8.5 × 14 inches) Half letter (5.5 × 8.5 inches) Executive (7.5 × 10 inches)	Plain paper and special ink jet papers distributed by EPSON	0.003 to 0.004 inch (0.08 to 0.11 mm)	17 to 24 lb (64 to 90 g/m ²)
Transparencies and glossy media	Letter (8.5 × 11 inches) A4 (210 × 297 mm) A6 (105 × 148 mm, glossy film only)	Transparencies, glossy paper, and glossy film distributed by EPSON	—	—

Photo Paper	4 × 6 inches (102 × 152 mm) Letter (8.5 × 11 inches) A4 (210 × 297 mm) Panoramic (8.27 × 23.4 inches)	Photo Paper distributed by EPSON	—	—
Photo stickers	A6 (105 × 148 mm) with 16 frames	Photo stickers distributed by EPSON	—	—
Self adhesive sheets and iron-on cool peel transfer paper	A4 (210 × 297 mm) Letter (8.5 × 11 inches; cool peel transfer paper only)	Self adhesive sheets and iron-on cool peel transfer paper distributed by EPSON	—	—
Envelopes	#10 9.5 × 4.1 inches (240 × 104 mm) DL 8.7 × 4.3 inches (220 × 110 mm) C6 4.4 × 6.4 inches (114 × 162 mm) Note card envelope 5.2 × 8.7 inches (132 × 220 mm)	Plain, bond, or air mail paper	0.006 to 0.02 inch (0.16 to 0.52 mm)	12 to 20 lb (45 to 75 g/m ²)
Ink Jet cards	A6 (105 × 148 mm) 8 × 10 inches (203 × 254 mm)	Ink jet cards distributed by EPSON	—	—



Note:

Print only under these conditions:

Temperature: 59 to 77 °F (15 to 25 °C)

Humidity: 40 to 60% RH

Store glossy film and self adhesive sheets under these conditions:

Temperature: 59 to 86 °F (15 to 30 °C)

Humidity: 20 to 60% RH

Since the quality of any particular brand or type of paper may be changed by the manufacturer at any time, EPSON cannot guarantee the use of any particular brand or type of paper. Always test samples of paper stock before purchasing large quantities or printing large jobs.

Poor quality paper may reduce print quality and cause paper jams and other problems. If you encounter problems, switch to a higher grade of paper. Do not load curled or folded paper, envelopes, or transparencies.

Printable area

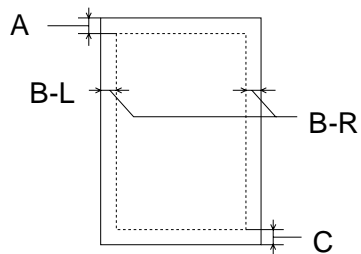

Single sheets and cards

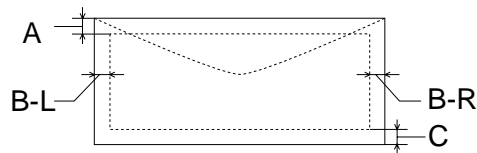

Envelopes

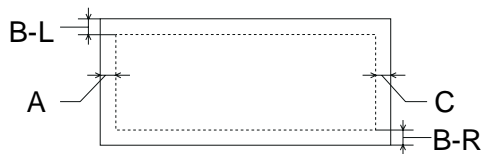

EPSON Panoramic
Photo Paper



Note:
Always load paper
into the sheet feeder
short edge first
except envelopes.
Load envelopes long
edge first.

- A The minimum top margin is 0.12 inch (3.0 mm).
When printing multiple sheets of EPSON Photo Quality Glossy Film, the minimum top margin is 1.2 inches (30 mm).
- BL The minimum left margin is 0.12 inch (3.0 mm).
- BR The minimum right margin is:
0.35 inch (9.0 mm) for Letter and Legal
1.10 inches (28 mm) for #10 envelopes
0.28 inch (7 mm) for DL envelopes
0.12 inch (3.0 mm) for all other paper sizes.
- C The minimum bottom margin is 0.55 inch (14.0 mm) using the Standard printable area setting. This can be decreased to 0.12 inch (3.0 mm) using the Maximum printable area setting. However, the print quality in the expanded printable area may be reduced.

Ink Cartridges

Specification	Black ink cartridge (S020189)	Color ink cartridge (S020191)
Color(s)	Black	Cyan, magenta, and yellow
Print capacity*	900 pages text (ISO/IEC 10561 letter pattern) 300 pages graphic (5% coverage)	300 pages (15% coverage)
Cartridge life	2 years from production date and up to within 6 months after opening package at 77 °C (25 °F)	
Storage temperature	-4 to 104 °F (-20 to 40 °C) 1 month at 104 °F (40 °C)	
Transit temperature	-22 to 140 °C (-30 to 60 °F) 1 month at 104 °F (40 °C) 120 hours at 140 °F (60 °C)	
Freezing temperature**	3.2 °F (-16 °C)	-0.4 °F (-18 °C)
Dimensions	1.09 (W) × 2.1 (D) × 1.5 (H) inches 27.8 (W) × 52.7 (D) × 38.5 (H) mm	1.7 (W) × 2.1(D) × 1.5 (H) inches 42.9 (W) × 52.7 (D) × 38.5 (H) mm

* The print capacity may vary depending on how often you clean the print head.

** The ink thaws and is usable after approximately 3 hours at 77 °F (25 °C).



Caution:

To ensure good results, use genuine EPSON cartridges and do not refill them. Other products may cause damage to your printer not covered by EPSON's warranty.

Do not use an ink cartridge after the expiration date on the package.

Mechanical

Paper feed method	Friction with auto sheet feeder, rear entry
Sheet feeder capacity	Maximum 100 sheets of 17 lb (64 g/m ²) paper
Dimensions	
Storage	Width: 16.9 inches (429 mm) Depth: 10.3 inches (261 mm) Height: 6.6 inches (167 mm)
Printing	Width: 16.8 inches (429 mm) Depth: 24.1 inches (613 mm) Height: 12.2 inches (309 mm)
Weight	11.5 lb (5.2 kg) without the ink cartridges

Electrical

Specification	120V model	240V model*
Input voltage range	99V to 132V	198V to 264V
Rated frequency range	50 to 60 Hz	
Input frequency range	49.5 to 60.5 Hz	
Rated current	0.4A	0.2A
Power consumption	Approx. 18 W (ISO 10561 Letter Pattern) Approx. 5 W in standby mode	

* Also designed for IT power systems with Phase to Phase voltage 220–240V

Environmental

Temperature	Operation	50 to 95 °F (10 to 35 °C)
	Storage*	–4 to 104 °F (–20 to 40 °C) 1 month at 104 °F (40 °C)
	Transit*	–4 to 140 °F (–20 to 60 °C) 120 hours at 140 °F (60 °C)
Humidity	Operation	20 to 80% RH
	Storage*	5 to 85% RH (without condensation)

* Stored in shipping container

Safety Approvals

Safety standards	UL 1950, CSA 22.2 No. 950
EMC	FCC part 15 subpart B class B

DOS Support

If driver support for the EPSON Stylus COLOR 740 is not available from your software manufacturer, you can use one of the other EPSON ESC/P 2 printer drivers. These drivers don't provide all the EPSON Stylus COLOR 740 features, such as 720 or 1440 dpi printing. Choose the first printer available from the following two lists:

- | | |
|--------------------------|--|
| Black printing only | <ul style="list-style-type: none">▶ LQ-870/1170▶ LQ-570(+)/1070(+)▶ SQ-870/1070▶ LQ-850▶ LQ-500 |
| Color and black printing | <ul style="list-style-type: none">▶ EPSON Stylus PRO▶ EPSON Stylus COLOR 500▶ EPSON Stylus COLOR II▶ LQ-860▶ LQ-2550 |



Control Panel Settings

You can change the following default settings from the printer's control panel:

Setting	Options
Font	Courier, Roman, Sans Serif, Prestige, Script, Roman T, Sans Serif H, Draft
Character table	Italic U.S.A., Italic France, Italic Germany, Italic U.K., Italic Denmark 1, Italic Sweden, Italic Italy, Italic Spain 1, PC 437 (U.S./Standard Europe), PC850 (Multilingual), PC860 (Portuguese), PC861 (Icelandic), PC863 (Canadian-French), PC865 (Nordic), Abicomp, BRASCI, Roman 8, ISO Latin 1

Changing control panel settings

Follow these steps to change the settings listed above:

- 1 Make sure the printer is turned off and has paper loaded (at least 8.27 inches [210 mm] wide).
- 2 Hold down the  cleaning button and press the  power button. The printer prints a summary of instructions for changing settings and choosing a language for the instructions.
- 3 Press the  load/eject button to print a list of current settings (indicated with arrows) and additional instructions.
- 4 After you make the changes you want, turn the printer off to save the settings. The settings remain in effect until you change them again.

Character Tables

All character tables except Italic are the same as the PC437 table for hex codes 00 through 7F. Additional characters are available for hex codes 80 through FF. You can select the following character tables through the control panel or software commands:

- ▶ PC437 (U.S./Standard Europe)
- ▶ PC850 (Multilingual)
- ▶ PC860 (Portuguese)
- ▶ PC861 (Icelandic)
- ▶ PC863 (Canadian-French)
- ▶ PC865 (Nordic)
- ▶ Abicomp
- ▶ BRASCI
- ▶ Roman 8
- ▶ ISO Latin 1
- ▶ Italic (no characters available for hex code 15)

International
character sets

You can select a number of international character sets with the control panel or the ESC R command. Other sets can only be selected with the ESC R command. You can select additional characters with the ESC (^ command.

Interfaces

Parallel interface

Forward channel

Specification	Description
Data format	8-bit parallel, IEEE-1284 compatibility mode
Synchronization	$\overline{\text{STROBE}}$ pulse
Handshake timing	BUSY and $\overline{\text{ACKNLG}}$ signals
Signal level	TTL compatible
Connector	57-30360 Amphenol connector or equivalent

Reverse channel

Specification	Description
Transmission mode	IEEE-1284 Nibble mode
Adaptable connector	57-30360 Amphenol connector or equivalent
Synchronization	Refer to the IEEE-1284 specification
Handshaking	Refer to the IEEE-1284 specification
Signal level	IEEE-1284 Level 1 device
Data transmission timing	Refer to the IEEE-1284 specification

Serial interface

Specification	Description
Standard	Based on RS-423
Synchronization	Synchronous
Bit rate	Approximately 1.8M bps
Handshaking	X-ON/X-OFF and DTR protocol
Word format	Data bit: 8 bits Parity bit: None Start bit: 1 bit Stop bit: 1 bit
Connector	8-pin mini-DIN
Recommended cable	Apple System Peripheral-8 cable (preferably Belkin brand)

USB interface

Specification	Description
Standard	Based on Universal Serial Bus Specifications Revision 1.0, Universal Serial Bus Device Class Definition for Printing Devices Version 1.0
Bit rate	12 Mbps (full speed device)
Data encoding	NRZI
Adaptable connector	USB Series B
Recommended cable length	6.5 feet (2 meters)

A

- Accessories, [83](#), [122](#), [165](#)
- Advanced mode, selecting, [33](#) to [34](#), [36](#) to [38](#)
- Advanced settings
 - color, [40](#) to [48](#)
 - layout, [59](#) to [75](#)
 - orientation, [48](#) to [52](#), [55](#) to [56](#)
 - paper size, [48](#) to [58](#)
 - print quality, [36](#) to [40](#)
 - project types, [33](#) to [36](#)
 - saving custom, [78](#) to [80](#)
 - special effects, [36](#) to [40](#)
- Aligning print heads, [131](#), [141](#)
- Automatic mode, [22](#), [29](#)

B

- Background printing
 - Macintosh, [29](#) to [31](#), [113](#) to [117](#)
 - Windows, [100](#) to [113](#)
- Banding, [140](#) to [141](#)
- Basic printing, [19](#) to [31](#)
- Bitmap files, [65](#) to [67](#)
- Blank pages, [160](#)

- Blurry printouts, [143](#) to [144](#)
- Brightness setting, [44](#)

C

- Cards, see Photo Quality Ink Jet Cards
- Character sets, international, [166](#), [175](#) to [176](#)
- Character tables, [166](#), [175](#) to [176](#)
- Characters, garbled, [157](#) to [158](#)
- Checking printer, [137](#) to [138](#)
- Cleaning print heads, [127](#) to [129](#)
- Cleaning printer, [132](#)
- Cleaning sheets, [84](#)
- Collate setting, [51](#), [58](#)
- Color Adjustment modes, [43](#) to [44](#)
- Color problems, [141](#) to [142](#)
- Color settings, customizing, [40](#) to [48](#)
- ColorSync, using, [35](#), [46](#) to [48](#)
- Configuration options, Macintosh, [119](#) to [120](#)
- Contrast setting, [44](#)
- Control code, [166](#)
- Control panel default settings, [175](#)

Control panel, using, [128](#) to [129](#),
[136](#) to [137](#), [175](#)
Iron-On Cool Peel Transfer Paper
 choosing, [82](#) to [83](#)
 loading, [84](#), [93](#)
 specifications, [168](#) to [170](#)
Custom settings
 color, [40](#) to [48](#)
 deleting, [80](#)
 layout, [59](#) to [75](#)
 orientation, [48](#) to [52](#), [55](#) to [56](#)
 paper size, [48](#) to [58](#)
 print quality, [36](#) to [40](#)
 project types, [33](#) to [36](#)
 redefining, [79](#) to [80](#)
 saving, [78](#) to [80](#)
 special effects, [36](#) to [40](#)
Cyan setting, [44](#)

D Default control panel settings, [175](#)
Default printer options, setting,
 [23](#) to [24](#)
Despooler, [26](#), [110](#)
Diagnosing problems, [135](#) to [139](#)
Diffusion, error, [39](#)
Digital Camera setting, [35](#), [41](#) to [42](#)
Dithering, [39](#)

DMA transfers, [98](#), [152](#)
DOS support, [19](#), [174](#)

E Economy setting, [35](#), [38](#)
Electrical specifications, [173](#)
Energy Star, [15](#)
Envelopes
 loading, [87](#)
 specifications, [168](#) to [170](#)
Environmental specifications, [173](#)
EPSON
 Accessories, [83](#), [122](#), [165](#)
 help, [164](#) to [165](#)
 media, [81](#) to [93](#)
 printer port, [97](#) to [98](#), [146](#), [157](#)
EPSON Spool Manager, see Spool
 Manager
Error Diffusion setting, [39](#)
Error notification, [105](#) to [108](#),
 [119](#) to [120](#)
ESC/P 2 control code, [166](#)

F Faint printouts, [143](#)
Film, see Photo Quality glossy media
Finest Detail setting, [40](#)
Fit to Page setting, [63](#), [69](#) to [71](#)

Flip Horizontal setting, [40](#), [93](#), [158](#)
Fonts, [166](#) to [167](#), [175](#)
Forms, loading, [85](#)

G Garbled characters, [157](#) to [158](#)
Glossy media, *see* Photo Quality
glossy media
Graph setting, [35](#), [42](#)

H Halftoning setting, [39](#), [141](#)
Head Cleaning utility, [127](#) to [128](#)
Help, [164](#) to [165](#)
High Speed copies, [97](#), [119](#) to [120](#)
High Speed setting, [39](#), [139](#), [141](#)
Horizontal banding, [140](#)

I ICM (Image Color Matching) setting,
[35](#), [45](#) to [46](#)
Ink
 cartridge specifications, [171](#)
 monitoring level, [108](#), [117](#) to [118](#)
 replacing cartridges, [122](#) to [126](#)
 replacing outdated cartridge, [126](#)
 setting, [22](#), [29](#), [34](#), [38](#), [141](#)
 smears, [87](#)
 specifications, [171](#)

Ink Jet Cards, *see* Photo Quality Ink
Jet Cards
Ink Jet Paper
 choosing, [21](#), [28](#), [82](#) to [83](#)
 loading, [84](#)
 specifications, [167](#) to [170](#)
Ink Jet Transparencies, *see*
Transparencies
Interface specifications, [177](#) to [178](#)
International character sets, [166](#),
[175](#) to [176](#)
Introduction, [9](#) to [18](#)

J Jammed paper, [136](#), [156](#)
Job Status window, [108](#) to [109](#)

L Landscape setting, [51](#), [56](#)
Layout
 icon, [29](#), [58](#), [70](#)
 options, setting, [59](#) to [75](#)
 problems, [158](#) to [159](#)
 tab, [22](#), [62](#)
Letterhead, loading, [85](#)
Lights, using, [136](#) to [137](#)

M Macintosh

- background printing, [29](#) to [31](#)
- ColorSync, [46](#) to [48](#)
- configuration options, [119](#) to [120](#)
- increasing memory allocation, [114](#)
- managing print jobs, [114](#) to [117](#), [119](#) to [120](#)
- Monitor3, [113](#) to [117](#)
- previewing, [30](#), [76](#) to [77](#)
- printing from, [27](#) to [31](#)
- problems printing, [149](#) to [154](#)
- Status Monitor, [117](#) to [118](#)
- system requirements, [10](#) to [11](#)
- uninstalling software, [162](#)

Magenta setting, [44](#)

Main tab, [21](#)

Maintaining printer, [121](#) to [132](#)

Manuals, how to use, [14](#) to [15](#)

Margin

- problems, [159](#)
- with multiple sheets, [85](#)

Mechanical specifications, [172](#)

Media Type setting, [21](#) to [22](#), [28](#) to [29](#), [34](#), [38](#), [82](#) to [83](#), [139](#)

Memory allocation, increasing on Macintosh, [114](#)

MicroWeave setting, [39](#), [140](#)

Monitor3, [113](#) to [117](#)

Monitoring

- ink level, [108](#), [117](#) to [118](#)
- preferences, Windows, [101](#) to [103](#)
- print jobs, *see* Background monitoring

More Settings dialog box, [36](#) to [46](#)

Moving printer, [133](#)

Multiple print layouts, [64](#) to [65](#), [72](#) to [73](#)

N Nozzle Check, [130](#)

O Orientation options, [48](#) to [52](#), [55](#) to [56](#)

Outdated ink cartridge, [126](#)

P Packing printer, [133](#)

Page frames, [64](#) to [65](#), [72](#) to [73](#)

Page Order options, [64](#), [72](#)

Page Setup dialog box, [27](#), [55](#)

Panoramic Photo Paper, *see* Photo Paper

- Paper
 - choosing, [82](#) to [83](#)
 - handling problems, [154](#) to [156](#)
 - loading, [84](#) to [93](#)
 - specifications, [167](#) to [170](#)
- Paper jams, [136](#), [156](#)
- Paper Size options, [48](#) to [58](#)
- Paper support, [85](#), [88](#)
- Paper tab, [22](#), [49](#)
- Paper thickness lever, [87](#), [90](#), [91](#), [141](#), [143](#)
- Parallel interface specifications, [177](#)
- Photo Paper
 - choosing, [21](#), [28](#), [82](#) to [83](#)
 - loading, [84](#), [88](#) to [90](#)
 - specifications, [168](#) to [170](#)
- Photo Quality glossy media
 - choosing, [21](#), [28](#), [82](#) to [83](#)
 - loading, [84](#) to [86](#)
 - specifications, [167](#) to [170](#)
- Photo Quality Ink Jet Cards
 - choosing, [82](#) to [83](#)
 - loading, [84](#), [91](#)
 - specifications, [168](#) to [170](#)
- Photo Quality Ink Jet Paper
 - choosing, [21](#), [28](#), [82](#) to [83](#)
 - loading, [84](#)
 - specifications, [167](#) to [170](#)
- Photo Quality Self Adhesive Sheets
 - choosing, [82](#) to [83](#)
 - loading, [84](#), [92](#)
 - specifications, [168](#) to [170](#)
- Photo Stickers
 - choosing, [82](#) to [83](#)
 - loading, [84](#), [92](#)
 - specifications, [168](#)
- PhotoEnhance setting, [34](#), [40](#) to [42](#)
- PICT files, [73](#) to [74](#)
- Plain paper, [21](#), [28](#), [167](#) to [170](#)
- Portrait setting, [51](#), [56](#)
- Preprinted forms, loading, [85](#)
- Previewing, Macintosh, [30](#), [76](#) to [77](#)
- Print dialog box, [20](#)
- Print Head Alignment utility, [131](#), [141](#)
- Print heads, cleaning, see Cleaning print heads
- Print jobs
 - managing in Windows, [95](#) to [113](#)
 - managing on Macintosh, [113](#) to [117](#), [119](#) to [120](#)
- Print layouts, multiple, [64](#) to [65](#), [72](#) to [73](#)
- Print Order options, [58](#) to [59](#)
- Print quality
 - customizing, [36](#) to [40](#)
 - problems, [139](#) to [144](#)

Print time, setting, [30](#) to [31](#),
[116](#) to [117](#)

Printable area
setting, [51](#), [56](#), [86](#), [140](#)
specifications, [170](#)

Printer check, [137](#) to [138](#)

Printer ID, checking, [138](#) to [139](#)

Printer parts, [13](#)

Printer port, EPSON, [97](#) to [98](#), [146](#),
[157](#)

Printer software
problems, [149](#) to [154](#)
settings, *see* Settings, printer
software
uninstalling, [161](#) to [163](#)

Problems
diagnosing, [135](#) to [139](#)
paper handling, [154](#) to [156](#)
print quality, [139](#) to [144](#)
printer software, [149](#) to [154](#)
printing, [145](#) to [148](#)
solving, [134](#) to [163](#)
unexpected printout results,
[157](#) to [160](#)
uninstalling software, [161](#) to [163](#)

Progress Meter
dialog box, [25](#)
Speed & Progress options,
[96](#) to [98](#)

Project types, custom, [33](#) to [36](#)

Q

Quality/Speed slider, [22](#), [29](#)

R

ReadMe files, [135](#)

Reduce/Enlarge setting, [50](#), [60](#) to [63](#)

Rendering Intent setting, [48](#)

Replacing ink cartridges, [122](#) to [126](#)

Resolution, *see* Print quality

Reverse Order setting, [51](#), [59](#)

Rotate by 180° setting, [51](#), [56](#)

S

Safety approvals, [174](#)

Safety instructions, [16](#) to [18](#)

Saturation setting, [44](#)

Self Adhesive Sheets, *see* Photo
Quality Self Adhesive Sheets

Serial interface specifications, [178](#)

Service, [164](#) to [165](#)

Settings, printer software
 advanced, *see* Advanced settings
 basic, [20](#) to [23](#), [27](#) to [31](#)
 default, [23](#) to [24](#)
 reusing on Macintosh, [27](#)

Sharpness setting, [42](#)

Smears, [87](#), [143](#) to [144](#)

Special effects, [36](#) to [40](#)

Specifications
 character tables, [166](#), [175](#) to [176](#)
 control panel settings, [175](#)
 DOS support, [174](#)
 electrical, [173](#)
 environmental, [173](#)
 ink cartridges, [171](#)
 interface, [177](#) to [178](#)
 mechanical, [172](#)
 paper, [167](#) to [170](#)
 printing, [166](#) to [167](#)
 safety approvals, [174](#)

Speed & Progress options, [25](#),
 [96](#) to [98](#)

Spool directory, changing default,
 [112](#) to [113](#)

Spool folders, [97](#), [119](#) to [120](#)

Spool Manager
 problems, [146](#), [150](#), [157](#)
 using with Windows 3.1,
 [110](#) to [113](#)
 using with Windows 95 and 98,
 [99](#) to [100](#)

sRGB (Standard Red Green Blue)
 setting, [35](#), [45](#) to [46](#)

Stalled print jobs, deleting, [100](#), [109](#),
 [112](#)

Status Alert dialog box, [102](#) to [103](#)

Status Monitor
 Macintosh, [117](#) to [118](#)
 problems, [135](#), [151](#)
 uninstalling, [161](#)
 Windows, [25](#), [100](#) to [109](#)

Support, [164](#) to [165](#)

System requirements, [10](#) to [12](#)

T

Technical specifications, [166](#) to [178](#)

Text/Graph setting, [35](#), [42](#)

Thickness lever, [87](#), [90](#), [91](#), [141](#), [143](#)

Tone setting, [42](#)

Transparencies
 choosing, [21](#), [28](#), [82](#) to [83](#)
 loading, [84](#) to [86](#)
 specifications, [167](#) to [170](#)

Transporting printer, [133](#)
Troubleshooting, [134](#) to [165](#)

U

USB interface specifications,
[10](#) to [12](#), [178](#)
User Defined paper size, [52](#) to [54](#),
[57](#) to [58](#)
Utility
 dialog box, [96](#), [117](#)
 icon, [127](#), [129](#), [131](#)
 tab, [127](#), [129](#), [131](#)

V

Vertical banding, [141](#)

W

Watermarks, [65](#) to [68](#), [73](#) to [75](#)
Windows
 default options, setting, [23](#) to [24](#)
 managing print jobs, [95](#) to [113](#)
 printing from, [19](#) to [24](#)
 problems printing, [149](#) to [154](#)
 system requirements, [11](#) to [12](#)
 uninstalling software, [161](#) to [162](#)

Windows 3.1
 default options, setting, [24](#)
 managing print jobs, [110](#) to [113](#)
 printer status, checking, [26](#)
 uninstalling software, [162](#)

Windows 95 and 98
 default options, setting, [23](#)
 managing print jobs, [95](#) to [109](#)
 printer status, checking, [25](#)
 Status Monitor 2, [25](#)
 uninstalling software, [161](#)

Windows NT
 default options, setting, [23](#)
 managing print jobs, [25](#), [95](#) to [98](#),
 [100](#) to [109](#)
 Status Monitor 2, [25](#), [100](#) to [109](#)
 uninstalling software, [161](#)

Y

Year 2000, [16](#)
Yellow setting, [44](#)